

FLUX CAPACITORS AND THE ORIGIN OF INERTIA

James F. Woodward
Departments of History and Physics
California State University, Fullerton
Fullerton, CA 92834
Email: jwoodward@fullerton.edu

ABSTRACT: The explanation of inertia based on “Mach’s principle” is briefly revisited and an experiment whereby the gravitational origin of inertia can be tested is described. The test consists of detecting a small stationary force with a sensitive force sensor. The force is presumably induced when a periodic transient Mach effect mass fluctuation is driven in high voltage, high energy density capacitors that are subjected to 50 kHz, 1.3 kV amplitude voltage signal, and threaded by an alternating magnetic flux of the same frequency. An effect of the sort predicted is shown to be present in the device tested. It has the expected magnitude and depends on the relative phase of the Mach effect mass fluctuation and the alternating magnetic flux as expected. The observed effect also displays scaling behaviors that are unique to Mach effects. Other tests for spurious signals suggest that the observed effect is real.

I. INTRODUCTION:

Over a century has passed since Ernst Mach conjectured that the cause of inertia should somehow be causally related to the presence of the vast bulk of the matter (his “fixed stars”) in the universe. Einstein translated this conjecture into “Mach’s principle” (his words) and attempted to incorporate a version of it into general relativity theory (GRT) by introducing the “cosmological constant” term into his field equations for gravity.¹ Einstein ultimately abandoned his attempts to incorporate Mach’s principle into GRT. But in the early 1950s Dennis Sciama revived interest in the “origin of inertia”.² Mach’s principle can be stated in very many ways. (Bondi and Samuel in a recent article list twelve versions, and their list is not exhaustive.³) Rather than try to express Mach’s principle with great subtlety, Sciama, in 1964, adopted a simple (and elegant) statement:⁴

Inertial forces are exerted by matter, not by absolute space. In this form the principle contains two ideas:

- (1) Inertial forces have a dynamical rather than a kinematical origin, and so must be derived from a field theory [or possibly an action-at-a-distance theory in the sense of J.A. Wheeler and R.P. Feynman. . .]*
- (2) The whole of the inertial field must be due to sources, so that in solving the inertial field equations the boundary conditions must be chosen appropriately.*

Taking into account the fact that the field produced by the chiefly distant matter in the universe must display the same universal coupling to matter as gravity to properly account for inertial reaction forces, the essence of Mach’s principle can be put into yet more succinct form: **Inertial reaction forces are the consequence of the gravitational action of the matter located in the causally connected part of the universe on objects therein accelerated by “external” forces.**

Already in 1953, in a vector approximation field theory of gravitation, Sciama, in analogy with Maxwell’s electrodynamics, had noted that the “gravitoelectric” field \mathbf{E} that acts on an object is given by:

$$\mathbf{E} = -\nabla\phi - \frac{1}{c} \frac{\partial \mathbf{A}}{\partial t}, \quad (1)$$

where c is the vacuum speed of light, and ϕ and \mathbf{A} are the scalar and three-vector parts of the four-potential of the gravitational field respectively. \mathbf{A} , by analogy with electrodynamics, is just the integral over all causally connected space (out to the particle horizon) of the matter current density, $\rho\mathbf{v}$, in each volume element divided by the distance r from the test particle to the volume element dV .

Sciama, for the case of a test particle being accelerated by an external force, argued that since the entire universe appears to be accelerating rigidly in the opposite direction from the point of view of the test particle, \mathbf{v} can be removed from the integration; and the remaining integral just yields the total scalar potential ϕ at the location of the accelerating test particle. As a result one finds that:

$$\mathbf{E} = -\nabla\phi - \frac{\phi}{c^2} \frac{\partial \mathbf{v}}{\partial t}. \quad (2)$$

In the simple case of a universe of constant matter density the gradient of ϕ vanishes at the test particle, and there is no gravitomagnetic force present because the curl of \mathbf{A} vanishes by symmetry. Indeed, \mathbf{E} vanishes too if \mathbf{v} is a constant. But when an external force acts to accelerate the test particle, then $\partial\mathbf{v}/\partial t$ is not zero, and the test particle experiences a gravitoelectric field produced by the gravitational action of the matter within the particle horizon. If ϕ/c^2 is equal to one, then the gravitoelectric force on the test particle (\mathbf{E} times the test particle mass) is exactly the inertial reaction force the accelerating agent experiences.

As Sciama noted, “‘inertia-induction’ arises from the term $\partial\mathbf{A}/\partial t$, that is, from the ‘radiation field’ of the universe.” And as, “The contribution of matter to local inertia falls off only inversely as the distance, since $\partial\mathbf{A}/\partial t$ is proportional to the scalar potential . . . This means that the main contribution comes from distant matter. . . .” As a result, “local phenomena are strongly coupled to the universe as a whole, but owing to the small effect of local irregularities this coupling is practically constant over the distances and time available to observation. . . .” Much discussion and disputation about Mach’s principle has taken place since Sciama penned these words. In 1975 Derek Raine showed that with suitable boundary conditions (those of “FRW” cosmologies) Mach’s principle as stated above is contained in GRT.⁵ But debate and discussion continued (Raine’s arguments, otherwise correct, did not take proper account of the energies ascribed to gravitational waves). So, to this day, it is still possible to assert that it has not been conclusively shown that the origin of inertia is the gravitational action of the matter in the universe. The only thing that seems likely to change this state of affairs is an experiment that conclusively and compellingly shows the gravitational origin of inertia.

2. TRANSIENT MACH EFFECTS:

Every time a non-gravitational force is exerted on an object and one notes that an equal and opposite inertial reaction force arises, Mach’s principle can be said to have been experimentally corroborated. But although this is correct, such corroboration does not necessarily mean that Mach’s principle is true, for claims that inertial reaction forces have other than gravitational origins can be, and have been, advanced. Just because Mach’s principle can be incorporated into Sciama’s vector theory of gravity and GRT (with suitable boundary conditions) does not mean that gravity necessarily is the origin of inertia. In addition to the inertia as an

innate property position, for example, one might claim that inertia arises from the action of quantum mechanical “zero point” fields (ZPFs). Had one a quantum theory of gravity, it might indeed be possible to formulate the action of the gravitational field of chiefly distant matter in terms of the action of a local gravitational ZPF. But that is not what it meant here. Rather, the claim has been advanced, for instance, that inertial reaction forces are caused by the action of the electromagnetic ZPF (photons).⁴ While compelling reasons exist to reject the electromagnetic ZPF account of inertia,^{5,6} perhaps some other non-gravitational ZPF might be made to work.

What we need to demonstrate the validity of Mach’s principle as formulated above, then, is experiments that detect effects *other than simple inertial reaction forces themselves* derived from the assumption that gravity is the cause of inertia. Such effects must have a unique Machian signature so that they cannot be ascribed plausibly to any other cause. Are such effects predicted? Yes. Predictions of this sort have been available in the published literature for more than a decade.⁷ The predicted phenomena in question arise from considering the effect of an “external” accelerating force on a massive test particle. Instead of assuming that such an acceleration will lead to the launching of a (ridiculously minuscule) gravitational wave and asking about the propagation of that wave, one assumes that the inertial reaction force the accelerating agent experiences is caused by the action of, in Sciama’s words, “the radiation field of the universe” and then asks, given the field strength as the inertial reaction force per unit mass, what is the local source charge density at the test particle? The answer is obtained by taking the four-divergence of the field strength at the test particle. The field equation that results from these operations is:

$$\nabla^2\phi - \frac{1}{\rho_0 c^2} \frac{\partial^2 E_0}{\partial t^2} + \left(\frac{1}{\rho_0 c^2} \right)^2 \left(\frac{\partial E_0}{\partial t} \right)^2 = 4\pi G \rho_0. \quad (3)$$

In this equation ϕ is the scalar potential of the gravitational field, ρ_0 the local proper matter density, E_0 the local proper energy density, c the vacuum speed of light, and G Newton’s constant of gravitation. This equation looks very much like a wave equation. However, the space-like part (the Laplacian) involves a scalar potential, whereas the time-like part (the time-derivatives) involve the proper rest energy density. (A full derivation of the Mach effects discussed here is given in Appendix A.)

Equation (3) can be put into the form of a standard classical wave equation by using Mach’s principle to “separate variables”, for Mach’s principle implies more than the statement above involving the origin of inertial reaction forces. Indeed, Mach’s principle actually implies that the origin of mass is the gravitational interaction. In particular, the inertial masses of material objects are a consequence of their potential energy that arises from their gravitational interaction with the rest of the matter in the causally connected part of the universe. That is, in terms of densities,

$$E_g = \rho\phi, \quad (4)$$

where E_g is the local gravitational potential energy density, ρ the local “quantity of matter” density, and ϕ the total gravitational potential at that point. (Note that it follows from Sciama’s analysis that $\phi \equiv c^2$, so Equation (4) is nothing more than the well-known relationship between mass and energy that follows from special relativity theory if E_g is taken to be the total local energy density.) Using this form of Mach’s principle, we can write:

$$E_0 = \rho_0\phi, \quad (5)$$

and this expression can be used in Equation (3) to affect the separation of variables. After some straight-forward algebra (recounted in Appendix A) we find that:

$$\nabla^2\phi - \frac{1}{c^2} \frac{\partial^2\phi}{\partial t^2} = 4\pi G\rho_0 + \frac{\phi}{\rho_0 c^2} \frac{\partial^2\rho_0}{\partial t^2} - \left(\frac{\phi}{\rho_0 c^2}\right)^2 \left(\frac{\partial\rho_0}{\partial t}\right)^2 - \frac{1}{c^4} \left(\frac{\partial\phi}{\partial t}\right)^2, \quad (6)$$

or, equivalently,

$$\nabla^2\phi - \frac{1}{c^2} \frac{\partial^2\phi}{\partial t^2} = 4\pi G\rho_0 + \frac{\phi}{\rho_0 c^4} \frac{\partial^2 E_0}{\partial t^2} - \left(\frac{\phi}{\rho_0 c^4}\right)^2 \left(\frac{\partial E_0}{\partial t}\right)^2 - \frac{1}{c^4} \left(\frac{\partial\phi}{\partial t}\right)^2. \quad (7)$$

This is a classical wave equation for the gravitational potential ϕ , and notwithstanding the special circumstances invoked in its creation, it is general and correct, for when all the time derivatives are set equal to zero, Poisson's equation for the potential results. That is, we get back Newton's law of gravity in differential form.

Some of the implications of this equation [either (6) or (7)] have been addressed elsewhere.^{7,8} Here we note that the transient source terms on the RHS can be written:

$$\delta\rho_0(t) \approx \frac{1}{4\pi G} \left[\frac{\phi}{\rho_0 c^4} \frac{\partial^2 E_0}{\partial t^2} - \left(\frac{\phi}{\rho_0 c^4}\right)^2 \left(\frac{\partial E_0}{\partial t}\right)^2 \right], \quad (8)$$

or, taking account of the fact that $\phi/c^2 = 1$,

$$\delta\rho_0(t) \approx \frac{1}{4\pi G} \left[\frac{1}{\rho_0 c^2} \frac{\partial^2 E_0}{\partial t^2} - \left(\frac{1}{\rho_0 c^2}\right)^2 \left(\frac{\partial E_0}{\partial t}\right)^2 \right], \quad (9)$$

where the last term in Equations (6) and (7) has been dropped as it is always minuscule. It is in the transient proper matter density effects – the RHSs of Equations (8) and (9) – that we seek evidence to demonstrate that the origin of inertia, as conjectured by Mach, Einstein, Sciama, and others, is in fact the gravitational interaction between all of the causally connected parts of the universe.

3. EXPERIMENT:

The obvious way to test for the presence of proper matter density fluctuations of the sort predicted in Equations (8) and (9) is to subject capacitors to large, rapid voltage fluctuations. Since capacitors store energy in dielectric core lattice stresses as they are polarized, the condition that E_0 vary in time is met as the ions in the lattice are accelerated by the changing external electric field. If the amplitude of the proper energy density variation and its first and second time derivatives are large enough, a detectable mass fluctuation should ensue. That mass fluctuation, δm_0 , is just the integral of $\delta\rho_0(t)$ over the volume of the capacitor, and the corresponding integral of the time derivatives of E_0 , since $\partial E_0/\partial t$ is the power density, will be:

$$\delta m_0 = \frac{1}{4\pi G} \left[\frac{1}{\rho_0 c^2} \frac{\partial P}{\partial t} - \left(\frac{1}{\rho_0 c^2} \right)^2 P^2 \right], \quad (10)$$

where P is the instantaneous power delivered to the capacitor. *Note that the assumption that all of the power delivered to the capacitors ends up as a proper energy density fluctuation is an optimistic, indeed, perhaps wildly optimistic, assumption.* Nonetheless, it is arguably a reasonable place to start.

How are we to test for the presence of such mass fluctuations? Since the second term on the RHS of Equation (7) is hopelessly small in all but very special “just so” conditions, it seems that it can be ignored. In order to make the first term on the RHS as large as possible, we need to maximize $\partial P/\partial t$. In a “one shot”, or pulsed “one shot” system this can be done by making the switching on, or off, of the voltage to the capacitor being tested as quick as possible. The mass fluctuation, of course, will only persist during the very brief switching process, so any weighing system designed to detect the transient mass fluctuation will either have to be exceedingly fast, or be a sufficiently sensitive ballistic system to detect small impulses. The speed requirement for the weigh system also obtains if we use an AC voltage signal to drive the mass fluctuations sought, for to produce a mass fluctuation of detectable magnitude, the frequency of the applied voltage signal will have to be as high as possible given the time-dependence. And while P , being the product of the voltage and the current delivered to the capacitors, is positive definite, $\partial P/\partial t$ is not. For a simple sinusoidal voltage signal, it is positive half of the time, and negative the other half of the time – so it time-averages to zero.

In early attempts to detect mass fluctuations predicted in Equation (10) a weigh sensor with a natural frequency of about 100 Hz was used, and the mass fluctuation was driven at that frequency.⁹ Since the frequency of the mass fluctuation occurs at the power frequency of the applied voltage, the applied voltage frequency is one half that of the power wave. That is, in this

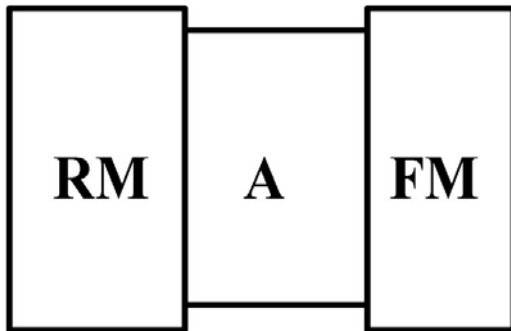

Figure 1: Schematic diagram of a Mach effect “impulse engine”.

case, about 50 Hz. Even with a large voltage amplitude, at this frequency any mass fluctuation is quite small in laboratory scale systems. While positive results were obtained, various sources of potential spurious signals could not be entirely eliminated. Larger mass fluctuations are expected at higher frequencies, at least for the first term on the RHS of Equation (10), for if P is sinusoidal, then $\partial P/\partial t$ scales linearly with the frequency. But to be detected with a relatively “slow” weigh system, a way to effectively “rectify” the mass fluctuation must be found. The mass fluctuation itself, of course, cannot be “rectified”; but its physical effect can be rectified by adding two components to the capacitor in which a mass fluctuation is driven.¹⁰ Those additional components are an electromechanical actuator (customarily made of lead-zirconium-titanate, so-called PZT) and a “reaction mass” (RM) located at the end of the actuator opposite the fluctuating mass (FM) element, as shown in Figure 1.

The principle of operation is simple. A voltage signal is applied to the FM element so that it periodically gains and loses mass. A second voltage signal is applied to the PZT actuator at the power frequency of the FM voltage signal. The relative phase is then adjusted so that, say, the PZT actuator is expanding when the FM element is more massive, and contracting when it is less massive. The inertial reaction force that the FM element exerts on the PZT actuator is

While positive results were obtained, various sources of potential spurious signals could not be entirely eliminated. Larger mass fluctuations are expected at higher frequencies, at least for the first term on the RHS of Equation (10), for if P is sinusoidal, then $\partial P/\partial t$ scales linearly with the frequency. But to be detected with a relatively “slow” weigh system, a way to effectively “rectify” the mass fluctuation must be found. The mass fluctuation itself, of course, cannot be “rectified”; but its physical effect can be rectified by adding two components to the

communicated through the actuator to the RM. Evidently, the reaction force on the RM during the expansion part of the PZT actuator cycle will be greater than the reaction force during the contraction part of the cycle. So, the time-averaged force on the RM will not be zero. Viewed from the “field” perspective, the device has set up a momentum flux in the “gravinertial” field – that is, the gravitational field understood as the cause of inertial reaction forces – coupling the FM to the chiefly distant matter in the universe that causes the acceleration of the mechanical system of Figure 1.

Formal analysis of this system is especially simple in the approximation where the mass of the RM is taken as effectively infinite, and the capacitor undergoes an excursion $\delta l = \delta l_0 \cos(2\omega t)$ under the action of the PZT with respect to the RM. We obtain for the time-averaged reaction force on the RM:

$$\langle F \rangle = -4\omega^2 \delta l_0 \delta m \sin(2\omega t) \sin(2\omega t + \varphi), \quad (11)$$

where φ is the phase angle between the PZT excursion and the mass fluctuation. Further algebra yields:

$$\langle F \rangle = -2\omega^2 \delta l_0 \delta m \cos\varphi \quad (12)$$

as the only term that survives the time-averaging process. Evidently, stationary forces can be obtained from mass fluctuations in this way.

It is worth noting at this point, however, if one naively (and incorrectly) includes the “ $\mathbf{v}dm/dt$ ” term in Newton’s second law as contributing to the reaction force on the RM, a term, when time-averaged over a cycle, that cancels the RHS of Equation (12) is recovered. In general, that this term does not contribute to the inertial reaction force on the RM follows from the fact that it does not represent a force *on* the FM that is communicated through the PZT to the RM. This is easily shown by noting that in the instantaneous frame of rest of the capacitor $\mathbf{v}dm/dt$ vanishes as \mathbf{v} in that frame is zero. Since the $\mathbf{v}dm/dt$ “force” that purportedly acts on the FM is zero in this inertial frame of reference must also be zero in all other frames of reference, it follows that a $\mathbf{v}dm/dt$ “force” does not act *on* the FM, and thence through the PZT on the RM. (This point is addressed in greater detail in Appendix B.)

When devices of the sort shown schematically in Figure 1 are constructed and operated in the (applied voltage) frequency range of 5 to 10 kHz, results of the sort expected are obtained.¹¹ At higher frequencies, however, where the dimensions of the device are comparable to the wavelength of the sound waves excited by the PZT actuator being used to “rectify” the effect, a problem that seriously degrades the performance of the devices becomes evident. The speed at which the rectifying force propagates through the device is soundspeed, whereas the speed at which the mass fluctuation propagates through the device is lightspeed. Consequently, as the frequency of operation increases, it becomes increasingly difficult to get the phase relationship between the mass fluctuation and rectifying force needed to see an effect established throughout a significant portion of the device. For typical materials in devices with dimensions of a few centimeters this problem is clearly manifested at frequencies as low as a few tens of kHz.

In principle, one might try to deal with this phasing problem by reducing the physical size of the devices as the intended operating frequency is raised. But by reducing the device size two problems arise. First, since the bulk of the device is reduced, so too is the total mass fluctuation and thus any rectified force. This may be addressed by running large arrays of such devices. Second, at ultrasound and radio frequencies the device size becomes sufficiently small that great care in design and elaborate fabrication techniques are needed. While these problems, given sufficient resources, are not insuperable, one may ask: Is there some other technique for

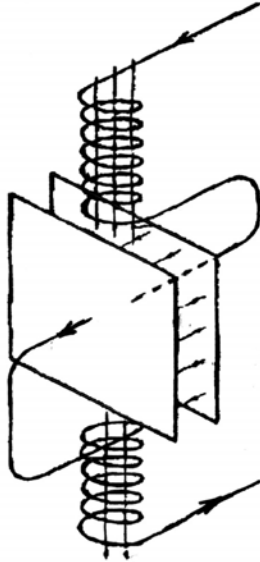

Figure 2: Schematic diagram of a "flux" capacitor.

producing stationary forces from Mach effect mass fluctuations that sidesteps the phasing problem so that macroscopic devices can be employed?

Naturally, the answer to this question is yes. The system that permits one to apply a rectifying force throughout the dielectric in a capacitor where Mach effect mass fluctuations are being driven by the application of a strong alternating electric field at lightspeed is shown in Figure 2. It consists of an inductor and capacitor wired in series with the inductor disposed so that the magnetic field it produces threads the capacitor perpendicular to the electric field in the dielectric. The magnetic flux in the dielectric, consequently, interacts with the electrically induced displacement current. Devices of the sort shown in Figure 2 we shall call "flux capacitors" for the obvious reason that they are capacitors threaded by high flux magnetic fields.

The flux capacitor system has long been investigated as one in which stationary electromagnetic forces might be generated by strictly electromagnetic actions. The preferred scheme of this sort invokes the "Heaviside force", a body force present in the capacitor even if the region between the plates is a vacuum that follows from adopting Minkowski's formulation of the electromagnetic stress tensor. (See Corum, *et al.*,¹² [also the source of Figure 2] and Brito and Elaskar¹³ for discussions of attempts to recover stationary forces from purely electromagnetic systems of this sort.) And the magnetic part of the Lorentz force, that is, the second term on the RHS in:

$$\mathbf{F} = q \left[\mathbf{E} + \left(\frac{1}{c} \right) (\mathbf{v} \times \mathbf{B}) \right], \quad (13)$$

acting on the displacement current present in the region between the capacitor plates has also been considered in this connection. Indeed, Brito claims to have seen small stationary forces (on the order of a dyne) in a system where the configuration of Figure 2 is optimized as shown in Figure 3.

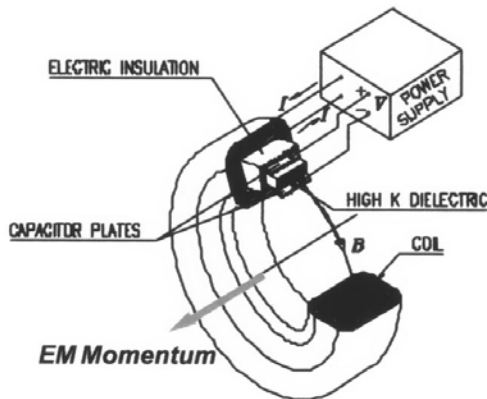

Figure 3: Schematic diagram of one of Brito's toroidal flux capacitors.

Purely electromagnetic force generation schemes in these systems, even those with non-linear components, cannot work without violating momentum conservation (see Woodward, 2003 and refs. therein), and accordingly can be set aside as untenable. Elaborate analysis is not needed to appreciate this point. All one need do is imagine the apparatus that supposedly generates some measurable electromagnetic thrust is enclosed in a Faraday cage. Since all electromagnetic effects are trapped within the cage, clearly no net momentum can be generated in the contents of the cage. Accordingly, the cage and its contents cannot be made to accelerate steadily in any direction as a result of any purely electromagnetic effects in the cage.

When we take Mach effect mass

fluctuations into account, however, this situation changes, for the gravinertial coupling of local systems like those of Figures 2 and 3 to the chiefly distant matter in the universe is not constrained by the presence of a Faraday cage around the local system. The cage is transparent to the momentum flux in the gravinertial field caused by the electromagnetic manipulation of the dielectric material in the capacitor affected by applied \mathbf{E} and \mathbf{B} fields. Armed with the gravinertial field to effect momentum transfer between a flux capacitor and the (chiefly) distant matter in the universe, we pose the question: Can the actions of the \mathbf{E} and \mathbf{B} fields on the dielectric in a flux capacitor be arranged so as to produce a detectable stationary force on it, enabling us to determine whether the Mach effect mass fluctuations predicted here in fact exist? If our flux capacitor is made with a core material with a very high dielectric constant – on the order of 5,000 or more – and it is subjected to an alternating voltage with a sufficiently large amplitude – say more than a kilovolt – and frequency – more than several tens of kHz – then mass fluctuations on the order of several percent of the mass of the dielectric core should ensue under the action of the \mathbf{E} field. With a sufficiently large “rectifying” force provided by the \mathbf{B} field, mass fluctuations of this size should be detectable as a stationary force on the order of a ten dynes or more.

We ignore the issue of mass fluctuations, for the moment, and focus on the force produced by the \mathbf{B} field in a flux capacitor. If a sufficiently large alternating \mathbf{B} field is applied to the flux capacitor, and the \mathbf{B} field is phased so that it is in phase with the displacement current induced by the \mathbf{E} field in the dielectric, a periodic force on the dielectric will be produced. If the frequencies of the \mathbf{B} field and the \mathbf{E} field, and thus the displacement current, are the same, and the \mathbf{B} field and \mathbf{E} field induced displacement current are in phase, then, because the signs of the \mathbf{B} field and displacement current reverse together, the dielectric will experience a periodic force. The force will always act in the same direction at twice the frequency of the exciting fields. This behavior does not mean that we have discovered a simple system in which momentum conservation is violated. The dielectric core material in the flux capacitor can be regarded as a tethered propellant. The excursions of the dielectric material in the core excited by the action of the \mathbf{B} field on the displacement current in the dielectric in turn excite lattice stresses that act as restoring forces during the intervals when the $\mathbf{i}_d \times \mathbf{B}$ force vanishes. This force goes to zero periodically because the ion velocity \mathbf{v} in the displacement current

$$\mathbf{i}_d = \sum q\mathbf{v}, \quad (14)$$

where the sum is over the ions with typical charge q in the dielectric, goes to zero periodically. (Note that since the displacement current is due to polarization of the dielectric induced by the \mathbf{E} field, ions of opposite signs will have velocities of opposite signs, so all ions will contribute to the displacement current with the same sign.) *If the masses of the constituents of the dielectric core material are constant*, then the time-average of the $\mathbf{i}_d \times \mathbf{B}$ and lattice restoring forces will be zero, and momentum in the flux capacitor system will be conserved (and time-average to zero).

If, however, the dielectric core material is undergoing a periodic mass fluctuation, and that mass fluctuation is in phase with the $\mathbf{i}_d \times \mathbf{B}$ /lattice restoring force, then the forces in the flux capacitor will not time-average to zero. So, to determine whether the flux capacitor system will permit us to explore the question of the existence of Mach effect mass fluctuations, we must first determine whether the predicted mass fluctuations have the same frequency and phase as the $\mathbf{i}_d \times \mathbf{B}$ force. That is, for this to work, the (absolute value of the) ion velocity \mathbf{v} in the dielectric must be in phase with the \mathbf{E} field-induced mass fluctuations so that the $\mathbf{i}_d \times \mathbf{B}$ /lattice restoring forces act when the mass fluctuations take place. As mentioned above, mass fluctuations in a capacitor due to the first term on the RHS of Equation (10) driven by a sinusoidal voltage occur at twice the frequency of the applied voltage since P is the product of the voltage and current in the capacitor circuit, and the product of two sinusoids of the same frequency is a sinusoid of twice that

frequency. We then note that the $\mathbf{i}_d \times \mathbf{B}$ force will have a frequency that is twice that of the applied magnetic field (which is the same as the capacitor voltage frequency). \mathbf{v} in Equation (14) arises from the action of the \mathbf{E} field, and the equation of motion [$q\mathbf{E} = \mathbf{F} = m\mathbf{a}$] for the ions in the lattice of the dielectric is easily integrated with respect to time to give a formal expression for \mathbf{v} . If initial conditions are chosen so that the position and acceleration of the ions are sines of the angular frequency ω and time t , then \mathbf{v} turns out to depend on the cosine of ωt . Since \mathbf{v} – and thus \mathbf{i}_d – and \mathbf{B} are orthogonal and in phase by design, their cross-product is just their simple product, and the product of two sinusoids of the same frequency returns a sinusoid of twice that frequency (and a phase dependent term) as required.

To show that the Mach effect mass fluctuation peaks when \mathbf{v} of the lattice ions due to the action of the \mathbf{E} field peaks, we first note that the impulse Mach effect is proportional to the second time-derivative of the proper energy density, and the proper energy density will be the rest-mass of the lattice ions plus their potential energy due to lattice stresses produced by the action of the \mathbf{E} field. With a sinusoidal applied \mathbf{E} field, after initial transients have settled out, there will be some fixed total energy added to the ions that will periodically shift between the kinetic and potential states. The peak kinetic energy for each ion will just be half the ion's mass times the square of its peak \mathbf{v} . The instantaneous ion potential energy will then be that peak kinetic energy minus the instantaneous value of the kinetic energy, or:

$$PE = \frac{1}{2} m \left(\frac{\mathbf{E}_0 q}{\omega m} \right)^2 [1 - \cos^2(\omega t)] = \frac{1}{2k} (\mathbf{E}_0 q)^2 [1 - \cos^2(\omega t)], \quad (15)$$

where \mathbf{E}_0 is the amplitude of the applied \mathbf{E} field, q the ion charge, m its mass, and k the “spring” constant of the lattice forces. (Since simple harmonic motion is assumed here, we may use the fact that $\omega = (k/m)^{1/2}$ to simplify the expression for the PE as above.) Applying trigonometric identities we find that:

$$PE = \frac{1}{4k} (\mathbf{E}_0 q)^2 [1 - \cos(2\omega t)]. \quad (16)$$

Since we are only interested in the phase of the Mach effect mass fluctuations with respect to the velocity of the ions in the lattice, and since ρ_0 is just the quiescent proper matter density plus the PE s of all of the lattice ions, it follows that:

$$\delta m \propto \frac{\partial^2 \rho_0}{\partial t^2} \propto \frac{\partial^2}{\partial t^2} [1 - \cos(2\omega t)]. \quad (17)$$

Taking the indicated derivatives we arrive at:

$$\delta m \propto 4\omega^2 \cos(2\omega t). \quad (18)$$

Or, writing K_1 for the constant of proportionality in Equation (10) [the coefficient of the trigonometric term in Equation (15)] and absorbing the 4 into that constant,

$$\delta m = K_1 \omega^2 \cos(2\omega t). \quad (19)$$

We thus see that the Mach effect mass fluctuations do indeed occur when the (absolute) velocities of the ions in the lattice of the core material are at a maximum since δm depends on $\cos(2\omega t)$ and $|\mathbf{v}|$ depends on $|\cos(\omega t)|$. As a result, we may reasonably expect that the application of the \mathbf{B} field described above will produce a force on the lattice ions when the Mach effect produces a fluctuation in their proper masses. And consequently, we may expect to see stationary thrusts in auspiciously engineered devices of this sort if Mach effect mass fluctuations actually occur. We defer a quantitative treatment of thrust production in this type of device to after the description of actual experimental apparatus and its operation.

4. APPARATUS:

While Brito's device, shown schematically in Figure 3 above, is elegant in its simplicity, toroidal capacitors with cores of very high dielectric constant are not commercially available off-the-shelf at modest cost. Nonetheless, hybrid devices that can be operated at significantly higher power can be assembled from common components that are both inexpensive and readily available. High voltage disk capacitors a few centimeters in diameter made with materials with dielectric constants in the range of 8000 to 9000 (roughly twice the dielectric constant of Brito's



Figure 4: The flux capacitor test device used in this experiment.

capacitors) are easily obtainable. And powdered iron or ferrite toroidal inductor cores likewise can be had in a variety of sizes at small cost. By splitting the the toroidal inductor into two halves and grinding flats on the disk capacitors, a device like that shown in Figure 4 can be fabricated The inductor core in this device is an Amidon T200-26 powdered iron torus about 5 cm. in diameter with a permeability of 75. Each of the halves of the torus is wound with five layers of

bifilar 22 AWG magnet wire (the layers being separated by Teflon tape). The windings of the two halves are connected in parallel. Connection to the magnet windings is made with a plug at the device so that the polarity of the current in the windings could be reversed without changing the currents elsewhere in the circuit for a test mentioned below.

The capacitors in this device are Vishay Cera-Mite disk capacitors 2.54 cm. in diameter and 0.82 cm. thick with threaded lugs soldered to the center of the plates. After grinding of the flats, given core material with a dielectric constant of 8500, each of the capacitors has a value of 5.5 nF. They are mounted on a threaded rod which is also the high voltage connection to the capacitors. The low voltage (ground) connection is made at the outer lugs which also serve as the mechanical support attachments for the entire device which is mounted in a Faraday cage, a box made of sheet steel, supported in a plastic frame atop the thrust sensor, as shown in Figure 5. Also shown in Figure 5 are the braid shielded power feeds and their connections to the capacitors

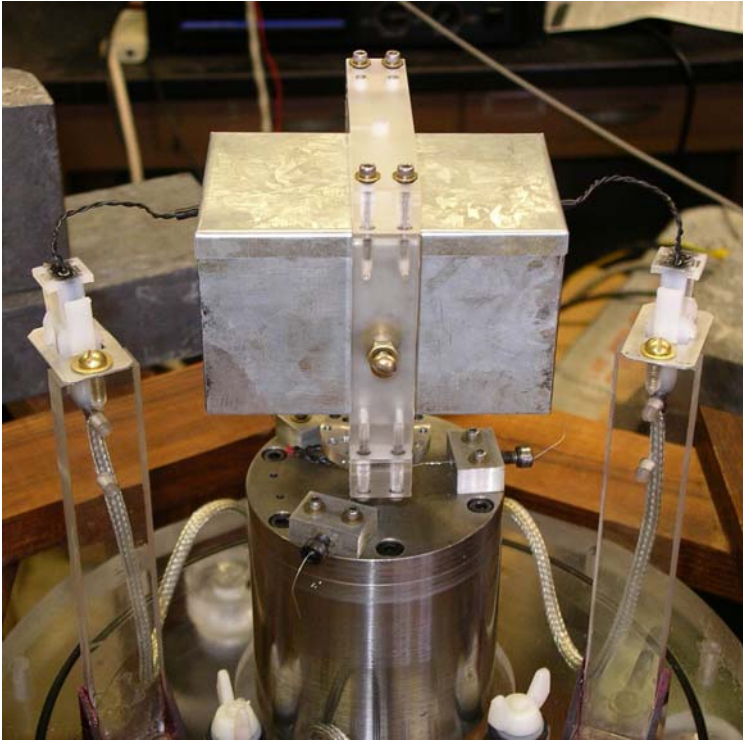

Figure 5: The Faraday cage (steel box) mounted atop the thrust/weight sensor (in the cylindrical steel shield).

which are wired as one leg of an adjustable Wheatstone bridge. The bridge voltage is amplified so that high sensitivity differential weight/thrust measurements can be made. (The bridge components, amplifiers, and 50 Hz. filter are mounted in cast aluminum project boxes, all of

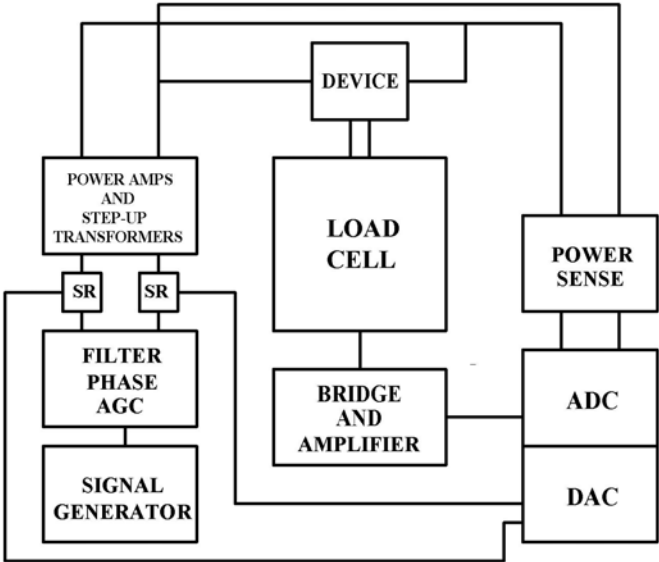

Figure 6: A schematic diagram of the chief electronic circuits in the apparatus.

and inductors inside the Faraday cage. The base of the vacuum chamber that encloses these components is visible at the bottom of the Figure. Normal operation was always carried out in a vacuum in the range of 15 to 25 milliTorr.

The thrust/weight sensor used in this experiment was that developed in earlier work. It is described in some detail in elsewhere.¹⁴ It is a Unimeasure U-80 position sensor fitted with a stainless steel diaphragm spring that converts it into a force sensor. Position of the shaft in the sensor is detected using two magneto-resistive Hall probes mounted on the shaft that move with the shaft in a fixed magnetic field supplied by small permanent magnets. That magnetic field determines the resistance of the Hall probes

which are wired as one leg of an adjustable Wheatstone bridge. The bridge voltage is amplified so that high sensitivity differential weight/thrust measurements can be made. (The bridge components, amplifiers, and 50 Hz. filter are mounted in cast aluminum project boxes, all of which are located in a double-walled steel box outside the vacuum chamber, to provide shielding from stray electromagnetic signals.) Data is acquired from this sensor at the 600 ADC counts per gram (or, roughly, 1000 dynes) level. So, with signal averaging, weight changes/thrusts at the level of a milligram/dyne can be resolved. Much of the one cm. thick steel case that shields the U-80 is visible in Figure 5, as are the blocks and screws that tension fine steel wires that support the upper end of the sensor shaft against lateral motion. Note that the parts of the power feeds between the high voltage connectors and the Faraday cage are flexible twisted pairs of wires that are disposed horizontally so that any thermal expansion of the feeds will

not communicate vertical forces to the assembly atop the thrust/weight sensor.

The other chief components of the apparatus, along with the test device and thrust/weight sensor, for this experiment are shown in a block diagram in Figure 6. The normally 50 kHz phase-locked/phase-adjustable sinusoidal signals that drive the inductor and capacitor circuits are produced with a garden-variety signal generator to which is added simple filter, automatic gain control (AGC), and phase adjustment circuits. The signals are amplified by two power amplifiers (Carvin DCM series amplifiers with output power ratings of one and two kilowatts respectively). Provision was made for phase shifting of 180 degrees with a simple switch so that cycles of data with alternating phase reversals could be taken easily. The signals to the power amplifiers were switched with computer controlled switching relays (SR). Since the output voltage swing of the power amplifiers was less than 100 volts, and much higher voltage signals were needed to operate the test device at full power, both of the power amplifiers were provided with toroidal stepup transformers (wound on Amidon T 300-26 powdered iron cores). Sense resistors (a 200 to 1 voltage divider and a 0.27 ohm current sense resistor) are included in the secondary circuits of the transformers in order to monitor the voltages and currents there (where the inductors and capacitors of the test device are located). The signals in the sense resistors are directly displayed on oscilloscopes for real-time monitoring, and four-quadrant multiplied and rectified to provide a recorded DC voltage that tracks the power in these circuits. The power levels present in the inductor and capacitor circuits during operation, together with the output of the thrust/weight sensor are the data recorded during trials of this system (by a Canetics PCDMA ADC board equipped with appropriate anti-aliasing filters).

5. PROTOCOLS:

Each cycle of data taken with this apparatus lasted seven seconds. For the first 2.7 seconds power was not applied to either of the components of the test device. At 2.7 seconds into each cycle one of the two power circuits was energized, usually the current in the inductor circuit. At three seconds into each cycle the second circuit was energized; and at four seconds the first circuit was switched off. The second circuit was then switched off 0.3 seconds later. This switching protocol was adopted for several reasons. First, by staggering the switching of the circuits the effect of each circuit acting alone on the system could be determined. Second, by taking data for 2.7 seconds before and after the powered part of each cycle the quiescent behavior of the system could be determined, making the estimate of the significance of any signal that might be present in the powered part of the cycles straight-forward. Third, the relatively short powered interval, 1.3 seconds for each circuit, was dictated by the presence of “dielectric ageing” in the capacitor core material which is a bit lossy (approximately 2% to 3%) and *very* sensitive to temperature. Indeed, in combination with the slow thermal dissipation in the system, this consideration also dictated that data be taken 12 to 14 cycles at a time with cool-down intervals of an hour or more between data cycle groups. Even so, decrease in the capacitor power level of 30% or more often took place during the acquisition of a group of cycles.

The cycles of each data group were alternated between either 0 and 180 degrees of relative phase between the inductor current and the capacitor voltage, or 90 and 270 degrees, yielding 6 or 7 cycles of each phase in the group. These relative phases were chosen because no Mach effect signal is expected at either 0 or 180 degrees as the magnetic flux in the capacitor peaks when the ion velocity is zero; whereas at 90 and 270 degrees, since the magnetic flux peaks when the ion velocity and Mach effect both peak, Mach effect signals are expected. And they should be equal and opposite at those two phases. Clustering the two pairs of phases also makes it easy to suppress “common mode” noise in the data by subtracting the 0 degree data from the 180 degree data, and the 90 degree data from the 270 degree data, since they are taken together at the same time and thus should be contaminated by spurious effects in equal measure. A real Mach effect signal, processed in this way, should emerge in the 270 minus 90 degree data as one

that turns on when both signals are present (at 3.0 seconds into each cycle) and turns off when one of the two signals is turned off (at 4.0 seconds). No *promptly switched* signal that persists for the duration of the powering of both circuits should be present in the 180 minus 0 degrees data.

Given the Faraday cage and the conservation of momentum, one should not see any promptly switched signal in the results of this experiment if Mach effects are not present and only electromagnetic forces are at work. Dropping the momentum conservation requirement, however, has led Brito to predict behavior similar to that expected on the basis of Mach effects. On the basis of his assumptions, he predicts:

$$\langle F \rangle = \frac{\epsilon_r \omega n I V d}{2c_0^2} \sin \varphi , \quad (20)$$

where ϵ_r is the dielectric constant of the capacitor core material (4400 in Brito's devices), ω the operating frequency (39 kHz), n the number of turns of the inductor (900 per device), I the amplitude of the current in the inductor coils, V the amplitude of the voltage across the capacitor plates (200 volts), d the length (or height) of the capacitor (8 mm), and φ the relative phase of the voltage in the capacitor and the current in the inductor (90 degrees for a peak effect – just as in Mach effect devices). With devices of this sort (three operated in tandem) Brito claims to have detected thrusts on the order of a dyne. Not much; but if true, either a violation of momentum conservation (as he notes), or evidence suggesting the presence of a Mach mass fluctuation effect. Accordingly, we need a way to discriminate a real Mach effect from Brito's predicted behavior which, assuming that momentum conservation is not violated in these systems, can be taken to stand for the most inauspicious spurious electromagnetic effects possible.

Since Brito's predicted effect displays the same phase dependence as Mach effect signals, we must look for some other signature to separate Mach effects from it. To do this we need a formal expression for the predicted Mach effect behavior. That is, we must put the Mach effect mass fluctuation predicted by the first term on the RHS of Equation (10) together with the action of the \mathbf{B} flux on the \mathbf{E} field induced displacement current in the capacitors to recover an expression that is the equivalent of Equation (12) for the simple system shown in Figure 1. The circumstances in the present devices, however, are somewhat more complicated even than those of Figure 1 devices. As in the case of Figure 1 devices, analytic solutions of the full equations of motion are not possible and simplifying assumptions must be made. We break the calculation up into parts.

The predicted mass fluctuation can be computed using Equation (10) above which, after differentiation of $P = P_0 \sin(2\omega t)$ and taking account of the fact that $\phi = c^2$, reads:

$$\delta m_0(t) \approx \frac{\omega P_0}{2\pi G \rho_0 c^2} \cos(2\omega t). \quad (21)$$

The action of the \mathbf{B} flux on the displacement current \mathbf{i}_d follows from the second term on the RHS of Equation (13):

$$\mathbf{F}_B = \mathbf{i}_d \times \mathbf{B} \times L , \quad (22)$$

where L is the length of the displacement current, that is, twice (because there are two capacitors) the separation distance of the plates of the capacitors. [Note that in Equation (22) we have switched from the Gaussian units of earlier sections to SI units.] Since \mathbf{i}_d and \mathbf{B} are orthogonal and have the same frequency, we may write:

$$F_B \approx Bi_d L \cos \varphi , \quad (23)$$

where φ is now the relative phase of B and I_d .

Now, the total force on the mechanical supports of the device, and thus the force that it exerts on the thrust/weight sensor, will be the inertial reaction forces to magnetic and lattice forces acting on the dielectric core material in the flux capacitors, or:

$$F_{tot} = -(F_B + F_{lat}) , \quad (24)$$

and in the absence of any Mach effect mass fluctuations, this will time-average to zero as F_B and F_{lat} act in opposite directions, each for half a cycle with equal strength once stationary operating conditions have been established. When Mach effect mass fluctuations are added to this behavior, the time-average of F_{tot} no longer vanishes in stationary circumstances if the phase relationship between F_B and i_d and δm_0 is such that F_B acts in phase with the mass fluctuation. The fractional part of the total proper mass due to the fluctuation will produce an inertial reaction force on the supports during the half-cycle that it acts that is not compensated during the other half cycle when the lattice forces act, for during that half-cycle the oppositely directed lattice force acts on a total proper mass that has a fractional component of the opposite sign due to the mass fluctuation. Since the signs of the force direction and mass fluctuation change together, that part of the inertial reaction force (relative to the force in the absence of mass fluctuations) will have the same sign as the fractional part of the force during the other half-cycle. This means that we can write for the time-averaged inertial reaction force on the device supports:

$$\langle F_{tot} \rangle = - \left(\frac{\delta m_0}{m_0} \right) F_B \sin \varphi , \quad (25)$$

where the phase angle φ is that between the voltage applied to the capacitors and the current in the inductors. We have not formally integrated the equations of motion of the device's parts to recover Equation (25). Neither have we taken into consideration the possibility that the second term on the RHS of Equation (10) may have an effect, nor have we considered the possibility that Mach effect mass fluctuations due to, say, the action of the \mathbf{B} field might have some effect on the operation of the test device. Nonetheless, adopting the simplifying assumptions implicit in these choices to get Equation (25) should at least give us an order of magnitude estimate of the size of the stationary force $\langle F_{tot} \rangle$ expected should Mach effect mass fluctuations actually occur.

6. OTHER SIGNATURES OF MACH EFFECTS IN FLUX CAPACITORS:

While a variety of tests can be carried out to guard against spurious signal sources, the best evidence for any effect is the demonstration that it scales in a distinctive way when various operating parameters are changed. Perhaps the most striking scaling behavior is that which occurs when the voltage of the power signal to the capacitors is altered. The Mach effect mass fluctuation, given by Equation (21), varies with the power, and the power scales with the *square* of the applied voltage. Varying the voltage, however, changes more than just the Mach effect mass fluctuation; it also changes the displacement current through the capacitors. The result is that the stationary thrust generated in one of the flux capacitor devices should scale with the *cube* of the voltage applied to the capacitors. That is, singling out those quantities that can be scaled by adjustment of the driving signals,

$$\langle F_{tot} \rangle \propto \omega P_0 B i_d, \quad (26)$$

and,

$$P_0 \propto i_d V_c \propto V_c^2, \quad (27)$$

$$i_d \propto V_c, \quad (28)$$

$$B \propto i_i. \quad (29)$$

The subscripts c and i are used to denote quantities relating to the capacitor and inductor circuits respectively. Note that the second proportionality in Relationship (27) and Relationship (28) are only generally true if the capacitance of the capacitors is independent of the operating frequency. Using these proportionalities, if the frequency and inductor current (and thus B) are held constant, it follows that:

$$\langle F_{tot} \rangle \propto V_c^3. \quad (30)$$

Taking Brito's prediction [Equation (20) above] as the stalking-horse for electromagnetic effects, we see that his effect scales only linearly with the voltage applied to the capacitors. And, of course, since no effect at all is the standard prediction, for that case there is no effect to scale in the first place.

Varying the frequency of operation produces a second distinctive scaling behavior. Since the Mach effect mass fluctuation scales linearly with the frequency as well as with the power, all other things held constant, any effect produced with mass fluctuations should display this scaling. For comparison, for example, with Brito's predicted effect, however, one would want to hold the amplitude of the voltage signal applied to the capacitors as nearly constant as possible while adjusting the frequency. P_0 in these circumstances ceases to be constant as the amplitude of the current in the capacitor circuit needed to produce a given V_c is a function of the operating frequency. Indeed, the current in the circuit, which is also i_d , scales linearly with the frequency when V_c is held fixed. So the scaling expected on the basis of Brito's (momentum non-conserving) purely electromagnetic hypothesis, which depends only on V_c and the current in the *inductors*, differs from that expected on the basis of Mach effect mass fluctuations. And, of course, if one expects no mass fluctuations for whatever reason, no thrust at all in these devices is expected. So checking for frequency scaling is a good way to test for the genuineness of any effect observed.

7. RESULTS:

The basic results of this experiment to test the Machian origin of inertia are contained in Figures 7 and 8. The weight/thrust traces (red and noisy) in those figures are averages of roughly 200 cycles. The individual results for each of the four indicated relative phases (0, 90, 180, and 270 degrees) of the capacitor voltage and inductor current are shown clockwise in the four panels (starting in the upper left hand corner of the figure). The main feature of these panels is easy to see: for 0 and 180 degrees there is no prompt thrust shift when the inductor power (blue trace) is shut off at 4 seconds, whereas for 90 and 270 degrees a prompt shift in the weight/thrust level of 10 to 15 dynes takes place. The promptness of the weight/thrust shift for 90 and 270 degrees when the capacitor power (green trace) is turned on is not as immediate owing to a switching

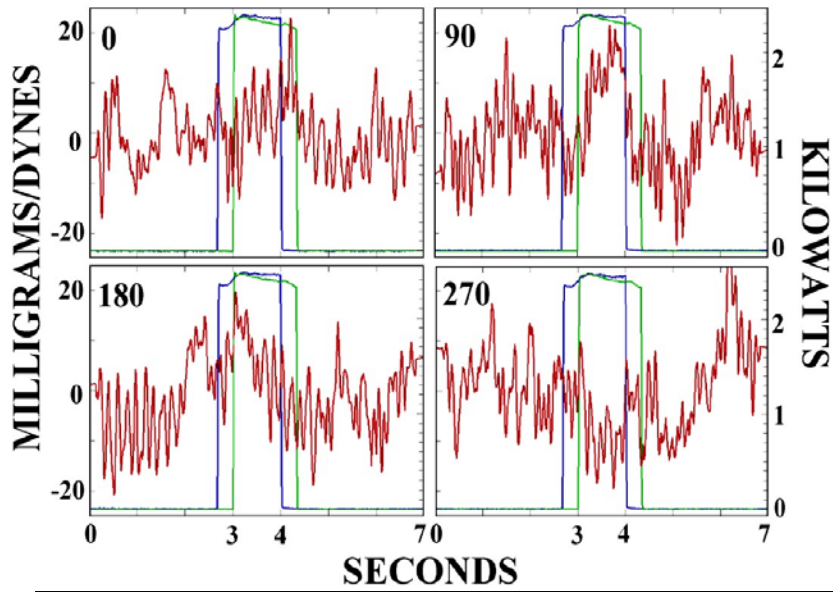

Figure 7: Results for the four relative phase angles of the inductor current and capacitor voltage.

transient that suppressed the response for a little more than a tenth of a second. That switching transient is also apparent (along with some drift) in the 0 and 180 degrees panels and so, evidently, is not due to the lowest order Mach effect mass fluctuation – which produces a stationary weight/thrust effect in any case.

relative phase data where no appreciable Mach effect is expected (indeed, ideally, none) and the 90 and 270 degree data where Mach effects of opposite sign are expected is to subtract the 0

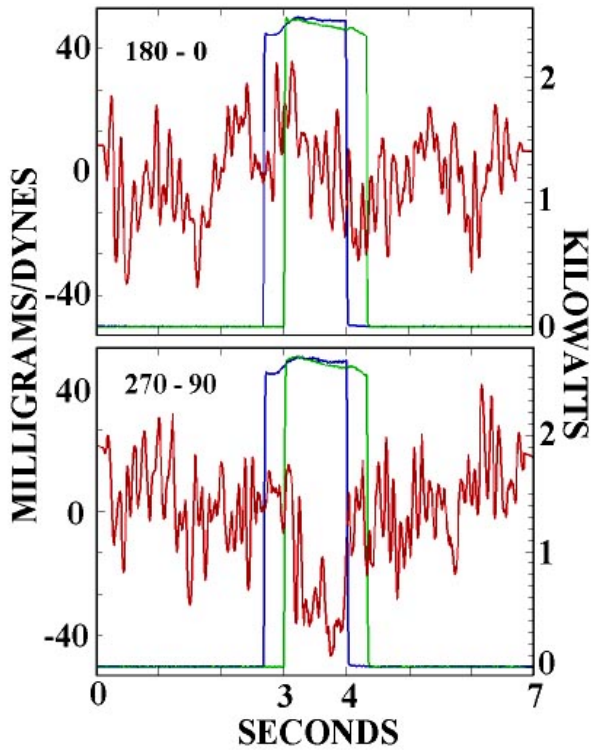

Figure 8: Differenced results for 180 minus 0 degrees and 270 minus 90 degrees. Note the prompt effect in the 270 minus 90 degrees data.

The easiest way to see the difference between the 0 and 180 degree degree data from the 180 degree data, and likewise do the same for the 90 and 270 degree data (as mentioned above). This subtraction procedure cancels all systematic effects present in the data that are uncorrelated to the relative phase of the capacitor and inductor power in the apparatus. Only signals that reverse with the relative phase survive the subtraction protocol. Inspection of the upper panel of Figure 8 reveals that the switching transient and subsequent drift in the 0 and 180 degrees data does reverse with phase, and so is present in the subtracted results. But no compelling persistent weight/thrust shift emerges in the 3 to 4 seconds interval.

The situation for the 90 and 270 degrees data is very obviously different. While the switching transient at 3 seconds in the 0 and 180 degree data is evident as the tenth of a second delay in the onset of the stationary response, a stationary response that promptly switches off at 4 seconds with the inductor power is plainly present in the 90 and 270 degree data. The net effect is a little more than 30 mg/dynes in this panel, indicating that the effect, presumably the Mach effect sought, is

about 15 mg/dynes. How closely does this correspond to prediction? The amplitude of the mass fluctuation, the coefficient of the cosine function on the RHS of Equation (21), can be calculated from knowledge of the operating frequency (50 kHz), power amplitude (2.5 kWatts), density of the material (roughly 5.6 gm/cm³), and the standard values of G and c . That turns out to be about 3.6 gm., a non-negligible fraction of the total mass of the active dielectric in the capacitors. The total mass of the dielectric is 43 gm. $\delta m_0/m_0$ thus is 0.084, nearly 10% of the quiescent mass of the dielectric core material in the capacitors. L is the sum of the thicknesses of the capacitors (1.6 cm), \mathbf{B}_v has the computed (on the basis of Ampere's Law) value 0.025 Tesla (250 Gauss), and i in the capacitor circuit is a little more than four amperes. So the current flowing through each capacitor, I_d , is about two amperes. This yields that F_B is about 80 dynes. So the stationary thrust given by Equation (25) in these circumstances is about 7 dynes – about half of the thrust actually observed. In view of the fact that several measured and estimated values enter into the computation of the effect, and each has an accuracy of plus or minus a few percent at best (though the precision is perhaps a bit better), agreement to a factor of two or three is quite good. (Only order of magnitude agreement had been hoped for.) More important than the exact

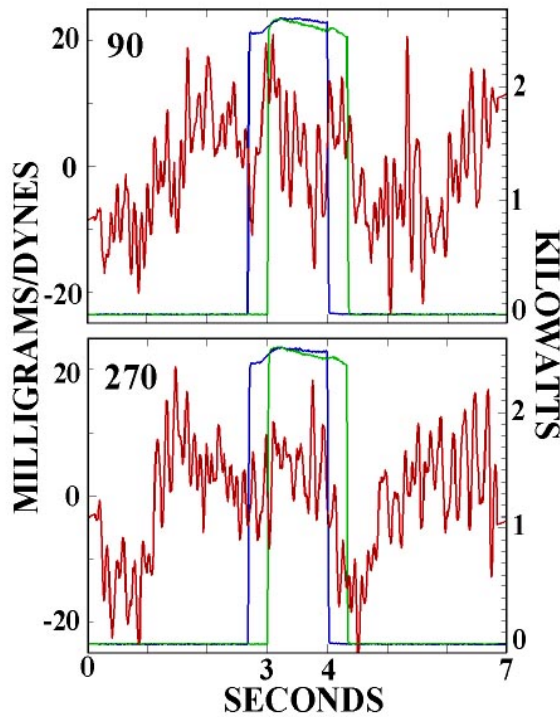

Figure 9: The 90 and 270 degrees results obtained when the polarity of the current in the inductors was reversed at the plug in the cage.

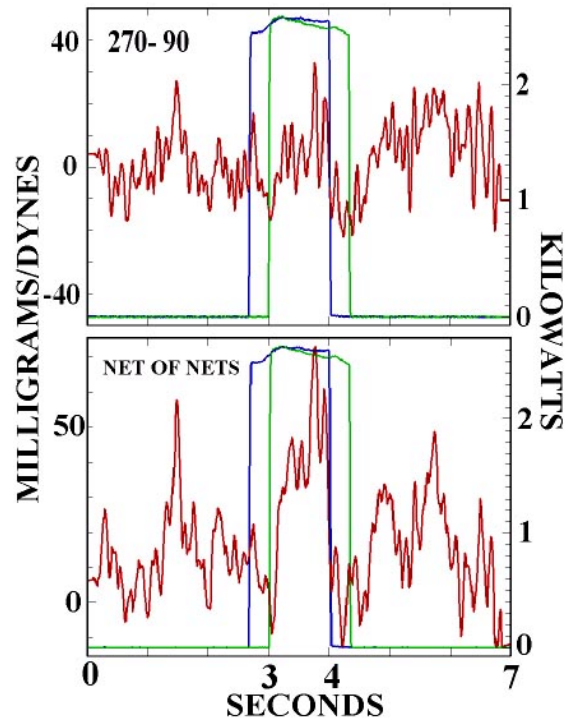

Figure 10: 270 minus 90 degrees results for reversed inductor polarity and those results with the other polarity subtracted.

agreement of prediction and observation, at this point at any rate, are experimental tests that challenge the interpretation of the observed effect as due to Mach effect mass fluctuations.

The first test of the results asks: Can the observed effect be a consequence of an interaction of the power circuits exterior to the Faraday cage that results in an apparent thrust on the cage? Given the phase dependence of the observed effect, there is a simple way to answer this question. One simply reverses the polarity of the current in the inductor by reversing the connections *at the plug inside the Faraday cage* (visible in Figure 4 above). If the effect is produced by the currents in the power feeds exterior to the cage, the observed phase dependence of the effect should not change when the driving signals are set to 90 and 270 degrees of relative

phase as before. If the effect is generated in the device inside the cage, however, the relative phase is actually reversed, and so too should be the observed effect. The results of this test are displayed in Figure 9. Comparison of the two panels of this figure with the corresponding panels of Figure 7 reveals immediately that the polarity reversal of the current in the inductors, at the inductors, reversed the sign of the stationary shift that is promptly switched at inductor power shut-off. Taking the 270 minus 90 degrees difference of these signals, shown in the upper panel of Figure 10, allows one to estimate the effect at inductor shut-off. It is between 20 and 30 milligrams/dynes; that is, about the same as the previous results. Indeed, taking the difference of these results and the previous 270 minus 90 degrees results allows one to suppress all “common mode” effects exterior to the Faraday cage. That “net of nets” result is displayed as the lower panel of Figure 10 (where a running time average over 0.1 second has been performed to suppress higher frequency noise in the signal). The signal present in this panel leaves no room for an argument that a real signal is not present in these data, or that the signal is not generated by the device within the Faraday cage. But it does not conclusively demonstrate that the signal is produced by the Mach effect mass fluctuations being acted upon by the magnetic flux generated by the inductors.

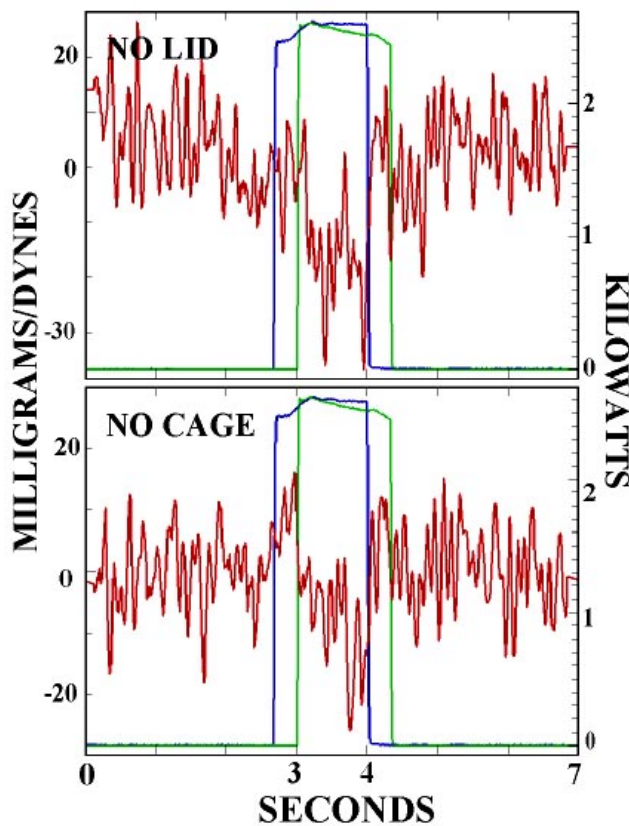

Figure 11: The 270 minus 90 degrees results obtained with all or part of the Faraday cage removed.

To demonstrate that the effects in Figures 7 through 10 are attributable to Mach effect mass fluctuations we must first show that the signals do not arise from electromagnetic coupling of the device to the thrust/weight sensor, notwithstanding that the device is run in a Faraday cage and the sensor is very carefully shielded. After all, leakage electric and magnetic fields are surely present, and perhaps they are strong enough to penetrate the Faraday cage and the weigh sensor shielding, and drive signals in the thrust/weigh sensor circuitry. The obvious way to eliminate this possibility is to intentionally compromise the Faraday cage to see what effect that has on the signals detected. This was done two ways. A sequence of 270 minus 90 degrees data was taken with the lid of the Faraday cage removed; and another sequence was done with the Faraday cage completely removed. Removal of part, or all, of the Faraday cage changed the loading of the thrust/weight sensor, and the mechanical response accordingly changed a bit. In the case of full removal of the cage the response is somewhat more sluggish than that for full shielding or with the lid

removed. No doubt this was a consequence of the removal of the support for the power feeds provided by the cage. But in neither case, shown in Figure 11, did the signal become dramatically larger (or smaller) than that in the bottom panel of Figure 8. Indeed, measuring the effect as that promptly switched when the inductor power is shut off at 4.0 seconds, it appears that the Mach effect is a bit smaller for the reduced shielding results – 10 to 12 dynes (half of the

switched weight shift in Figure 11) – than the signal obtained with full shielding. Since the result obtained with full shielding – 12 to 15 dynes – is larger than prediction, the reduced shielding results are still consistent with the predicted magnitude



Figure 12: The currents emulation test device.

The similarity between the responses with full shielding (bottom panel of Figure 8) and reduced shielding (Figure 11) might make one wonder if the correspondence might not be due to a simple electromagnetic coupling that is not screened by the Faraday cage for whatever reason. Unlikely though this may be, a test was carried out to insure that this was not the case. For this test, the capacitors in the test device were replaced by networks of bus wire, as shown in Figure 12. The capacitors were removed to the high voltage part of the circuit near the power amplifiers and step-up transformers. In this way essentially all of the currents driven in the apparatus were excited without the physical presence of the flux capacitors in the Faraday cage. Thus, if the observed effect were due to electromagnetic effects alone, one should see evidence of their presence in this configuration. Since no Mach effects are present in this configuration, no prompt displacement of the thrust/weight trace like those in Figures 8 and 11 should be present. The result of this test is displayed in Figure 13. The Mach prediction is corroborated.

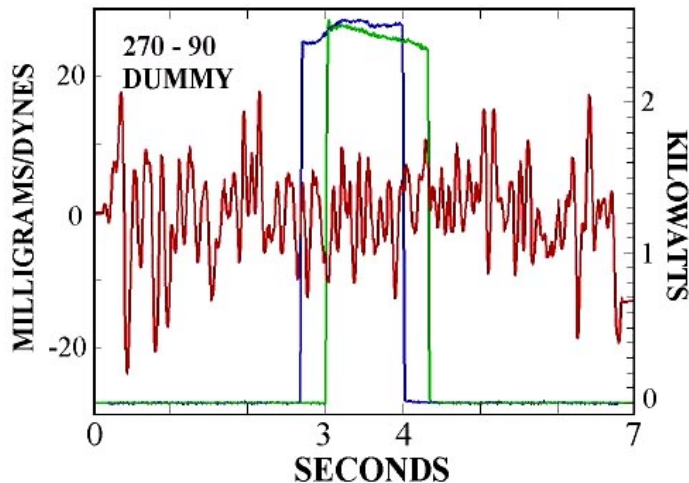

Figure 13: The currents emulation results for the dummy circuit in Figure 12.

Before moving on to the scaling tests, a few words about errors and the accuracy of the results presented here are in order. As far as the likelihood that the promptly switched effect present especially in the 90 and 270 degrees data can be attributed to random error, that can be estimated from the weigh/thrust sensor response in the traces of all of the data figures herein. There is no other feature that mimics the prompt switching in these figures. Accordingly, it seems reasonable to assume that the displayed effect, whatever its source, is real. As for the accuracy of the results, that is a matter of calibration procedures. In the case of the weigh sensor, it was calibrated by recording data cycles where a one gram mass was placed on the sensor, and then removed. About two dozen such cycles were averaged in order to compute ADC counts per gram scale factor that was applied to the raw data. That scale factor is accurate to better than a few percent of the sensor readings (and the sensor is linear over the sort differential weight/thrust readings involved in this experiment).

The power readings in the inductor and capacitor circuits are less accurate. Each of these circuits has a resistor network used to detect the instantaneous values of the voltage and current in them. The voltage is sensed as the drop across a 5 kilohm resistor in a 200 to 1 divider network. And the current is sensed as the voltage drop across a 0.27 ohm resistor in series with either the

inductor or the capacitor. The error with which the voltage divider is known is better than a percent or two. But the error in the current sense resistor value is on the order of ten percent. Since the power readings are obtained by four-quadrant multiplication of the voltage and current signals, those values are only known to an accuracy of about 10 percent. Nonetheless, since a little better than order of magnitude accuracy is all that was sought, the lack of better accuracy is not a matter of great moment at this point. The important question for now is: Are the signals recorded in this experiment evidence for the predicted Mach effect mass fluctuations? More light is shed on this question in the next section.

8. POWER AND FREQUENCY SCALING:

A real Mach effect mass fluctuation induced result in this experiment, in addition to surviving the phase dependence and spurious electromagnetic coupling tests of the previous

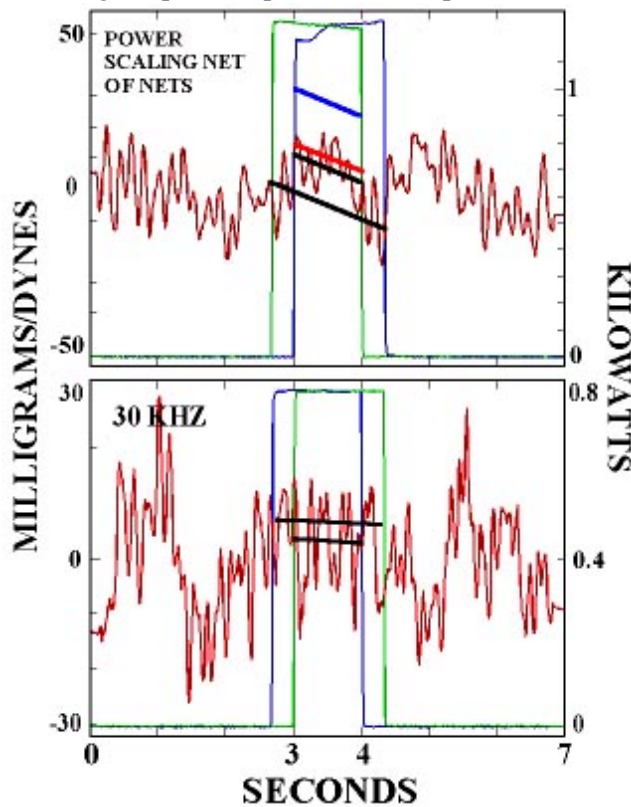

Figure 14: The results for the power scaling test (upper panel) and frequency/power scaling test (lower panel).

section must also display predicted scaling behavior if it is to be taken seriously. The test of power scaling was done by reducing the voltage signal driving the capacitors by a factor of 0.71 (± 0.02) so that the power driving the capacitor circuit would be halved. The current in the inductors was held constant, but since the displacement current in the capacitors was reduced by the factor 0.71, the magnetic force on the capacitors was reduced by this amount. Taken together, these considerations lead to the prediction that the effect seen should be reduced by a factor of 0.36. This test, crucial as it is, was performed with inductor polarity reversal, so its result is to be compared with the lower panel of Figure 10. From Figure 10 we see that the twice-differenced effect is about 50 dynes/milligrams. Thus we should expect a signal in the range of 15 to 20 dynes/milligrams. Were the effect observed due to a mechanism such as that proposed by Brito, it follows from Equation (20) that we would expect to see a signal twice as large. The result of this test is displayed in the upper panel of Figure 14, where several lines are

included to facilitate interpretation. The lowest line is the base line fixed by the weight traces in the intervals where only one of the two power signals is applied. Were no signal at all present in the domain where both power signals are applied, this line should roughly bisect the weight trace. It does not. The predicted weight traces are shown in red (Mach effect) and blue (Brito's effect). And a line that seems to track the actual shift is shown in black. Brito's effect is clearly inconsistent with the data. The Mach effect prediction scaled from the effect in Figure 10 is a somewhat larger than observation; but it is at least consistent therewith. Ironically, the observed effect at reduced power coincides very nicely with the formal prediction.

Ideally, in a frequency scaling test the only variable that would be changed would be the frequency. Owing to impedance matching problems, it was not possible to reduce the operating frequency to 30 kHz while maintaining the capacitor voltage amplitude at its 50 kHz level. (Scaling to a higher frequency was precluded because of yet more serious impedance matching problems.) The amplitude of the inductor current was held fixed (at 3 amperes), but the capacitor voltage amplitude had to be reduced by a factor of 0.7 to avoid serious distortion of the signal. This led to a reduction of the amplitude of the power signal in the capacitors by a factor of 0.34 (because the current in the capacitor circuit is a function of frequency). When the changes in the frequency, power, and displacement current in the capacitors are all figured in, the Mach effect prediction is that the thrust at 30 kHz should drop by a factor of 0.12. For the case of Brito's effect, the predicted reduction is by a factor of 0.42. In this case, the full polarity reversal/differencing protocol was not used. The result, displayed in the lower panel of Figure 14, is thus to be compared with the lower panel of Figure 8. Taking the 50 kHz effect to be 25 dynes/milligrams, the predictions then are Mach effect: 3 dynes; Brito's effect: 11 dynes. As for the simple power scaling result, lines have been included to facilitate interpretation. Evidently, the result of this test is consistent with the Mach effect, and not consistent with Brito's effect.

9. CONCLUSION:

What are we to make of the experimental results presented here? On their face, they seem to be a fairly straight-forward, reasonably complete case for the reality of Mach effect mass fluctuations and the possibility of producing thrust in flux capacitor systems. Further work will certainly show whether that is true. It is worth noting that since the Mach effect scales linearly with the frequency of the exciting signals when the power is held constant, the 2.5 kW power in the device used here activating a device operating at, say, 100 MHz (with a comparable inductor current amplitude) should produce on the order of 30,000 dynes (30 grams) of thrust. This may not seem very impressive, but it is enough, for example, to do International Space Station reboost with a single device – without the need for one-time-use propellant. So, in addition to shedding light on the origin of inertia and elementary issues of momentum conservation in systems of this sort, flux capacitors may have a practical application too if their operation can be successfully scaled to sufficiently high frequencies and powers.

ACKNOWLEDGEMENT:

I am indebted to far too many people to name them all individually here. But several deserve special mention. Thomas Mahood, Paul March, and Keith Wanser have provided ongoing general and technical support for many years now. Harold White, Jr. and Andrew Palfreyman have offered helpful criticism on a number of points. All of these people, and others too, have critically read one or another version of this paper. Ronald Crowley and Stephen Goode have both checked the derivation of the Mach effects on more than one occasion. Hector Brito, who has worked with flux capacitors now for many years, has also offered useful advice and criticism. Appendix B was stimulated by a critique by people in the Power Electronics and Electric Machinery division at Oak Ridge National Laboratory. This work could not have been done without the forbearance and support of my colleagues in the Department of Physics with whom it has been my pleasure to discuss some of the peculiar implications of Mach's principle from time-to-time.

REFERENCES

1. Hofer, C., "Einstein's Formulations of Mach's Principle," in: Barbour, J. and Pfister, H., *Mach's Principle: From Newton's Bucket to Quantum Gravity* (Birkhäuser, Boston, 1995) pp. 67 – 90.
2. Sciama, D., "On the Origin of Inertia," *Mon. Not. Roy. Astron. Soc.* **113**, 34-42 (1953).
3. Bondi, H. and Samuel, J., "The Lens-Thirring effect and Mach's principle," *Physics Lett. A* **228**, 121-126 (1997).
4. Sciama, D.W., " , " *Rev. Mod. Phys.* **36**, 463-469 (1964)
5. Raine, D.J., "Mach's principle in General Relativity," *Mon. Not. Roy. Astron. Soc.* **171**, 507-528 (1975).
4. Haisch, B., Rueda, A, and Puthoff, H., "Inertia as a zero-point-field Lorentz force," *Phys. Rev. A* **49**, 678 – 694 (1994).
5. Woodward, J. and Mahood, T., "What is the Cause of Inertia?," *Found. Phys.* **29**, 899 – 930 (1999)
6. Woodward, J., "Gravity, Inertia, and Quantum Vacuum Zero Point Fields," *Found. Phys.* **31**, 819 – 835 (2001).
7. Woodward, J., "Making the Universe Safe for Historians: Time Travel and the Laws of Physics," *Found. Phys. Lett.* **8**, 1 – 39 (1995).
8. Woodward, J., "Twists of Fate: Can We Make Traversable Wormholes in Spacetime?," *Found. Phys. Lett.* **10**, 153 – 181 (1997).
9. Woodward, J., "Measurements of a Machian Transient Mass Fluctuation," *Found. Phys. Lett.* **4**, 407 – 423 (1991).
10. Woodward, J., "A Stationary Apparent Weight Shift from a Transient Machian Mass Fluctuation," *Found. Phys. Lett.* **5**, 425 – 442 (1992).
11. Woodward, J., "A Laboratory Test of Mach's Principle and Strong-Field Relativistic Gravity," *Found. Phys. Lett.* **9**, 247 – 293 (1996).
12. Corum, J.F., Dering, J.P., Pesavento, P., and A. Donne, "EM Stress-Tensor Space Drive," *Space Technology Applications International Forum, Proceedings*, ed. M.S. El-Genk, American Institute of Physics, Woodbury, N.Y., 1999, AIP CP-458, pp. 1027-1032.
13. Brito, H.H. and S.A.Elaskar, 2003, "Direct Experimental Evidence of Electromagnetic Inertia Manipulation Thrusting," *AIAA/ASME/SAE/ASEE Joint Propulsion Conference and Exhibit, Proceedings*, AIAA Paper No. 2003-4989

14. Woodward, J., “The Technical End of Mach’s Principle,” in: M. Sachs and A.R. Roy, eds., *Mach’s Principle and the Origin of Inertia*, Apeiron, Montreal, 2003, pp. 19-36.
15. Brans, C.H., “Mach’s Principle and the Locally Measured Gravitational Constant in General Relativity,” *Phys. Rev.* **125**, 388 – 396 (1962).

APPENDIX A

Armed with the definition of Mach’s principle presented in the body of this paper, we tackle the detailed derivation of Equation (6) above (which was first obtained in complete form in ref. 7). The correct gravitational field equation, of course, is Einstein’s field equation of GRT, and the vector approximation to that equation is a set of Maxwell-like field equations. But for our purposes we are less interested in the field *per se* than we are in the *sources* of the field, for it is they that carry mass, and thus inertia. In GRT, and in its vector approximation, the sources of the field are *stipulated*. What we want to know, however, is: Does Mach’s principle tells us anything interesting about the nature of the sources of the field? To answer this question, it turns out, we do not need either the machinery of GRT or its vector approximation with their stipulated sources. We only need the relativistically invariant (*i.e.*, Lorentz invariant) generalization of Newtonian gravity, for that is all that is necessary to recover the transient matter terms found in Equation (6).

Why does this work? Because inertia is already implicitly built into Newtonian mechanics. The reason why it is possible to ignore the explicit contribution of the distant matter in the universe to local gravity is because of the *universality* of the gravitational interaction (crudely, it affects everything proportionately), as pointed out by Sciama and noted here, and so that contribution can always be eliminated by a coordinate (*i.e.*, gauge) transformation, as noted by Brans.¹⁵ [As an aside, this is the reason why gravitational energy is “non-localizable” in GRT, a well-known consequence of the Equivalence Principle in that theory.] Moreover, by demanding Lorentz invariance we insure that correct time-dependence is built into our simplest possible approximation to the field equation(s) of GRT.

To derive Equation (6) one considers a “test particle” (one with sufficiently small mass that it does not itself contribute directly to the field being investigated) in a universe of uniform matter density. We act on the test particle by, say, attaching an electric charge to it and placing it between the plates of a capacitor that can be charged with suitable external apparatus. That is, we accelerate the test particle by applying an external force. The acceleration, via Newton’s third law, produces an inertial reaction force in the test particle that acts on the accelerating agent. In view of the Machian nature of GRT and Sciama’s analysis of the origin of inertia, we see that the inertial reaction force produced in these circumstances is just the action of the gravitational field of the chiefly distant matter in the universe on the test particle as it is accelerated. So we can write the field strength of the gravitational action on the test particle as the inertial reaction force it experiences divided by the mass of the test particle (since a field strength is a force per unit charge, the “charge” in this case being mass). Actually, the standard form of field equations are expressed in terms of charge densities, so one has to do a volumetric division to get the force per unit mass expression into standard form. There are two critically important points to take into account here. The first is that the mass density that enters the field equation so constructed is the *matter density of the test particle, not the matter density of the uniformly distributed cosmic matter that causes the inertial reaction force*. The second point is that in order to satisfy Lorentz invariance, this calculation is done using the *four-vectors of relativistic spacetime*, not the three-vectors of classical space and time.

Formally, we make two assumptions:

1. Inertial reaction forces in objects subjected to accelerations are produced by the interaction of the accelerated objects with a field -- they are not the immediate consequence *only* of some inherent property of the object. *And from GRT and Sciama's vector approximation argument, we know that the field in question is the gravitational field generated by the rest of the matter in the universe.*

2. Any acceptable physical theory must be locally Lorentz-invariant; *that is, in sufficiently small regions of spacetime special relativity theory (SRT) must obtain.*

We then ask: In the simplest of all possible circumstances -- the acceleration of a test particle in a universe of otherwise constant matter density -- what, in the simplest possible approximation, is the field equation for inertial forces implied by these propositions? SRT allows us to stipulate the inertial reaction force \mathbf{F} on our test particle stimulated by the external accelerating force \mathbf{F}_{ext} as:

$$\mathbf{F} = -\mathbf{F}_{\text{ext}} = -\frac{d\mathbf{P}}{d\tau}, \quad (\text{A1})$$

with,

$$\mathbf{P} = (\gamma m_0 c, \mathbf{p}), \quad (\text{A2})$$

$$\gamma = \frac{1}{\sqrt{1 - \frac{v^2}{c^2}}}, \quad (\text{A3})$$

where bold capital letters denote four-vectors and bold lower-case letters denote three-vectors, \mathbf{P} and \mathbf{p} are the four- and three-momenta of the test particle respectively, τ is the proper time of the test particle, v the instantaneous velocity of the test particle with respect to us, and c the *vacuum* speed of light. *Note that the minus sign has been introduced in Equation (A1) because it is the inertial reaction force, which acts in the direction opposite to the acceleration produced by the external force, that is being expressed. One could adopt another sign convention here; but to do so would mean that other sign conventions introduced below would have to be altered to maintain consistency.* We specialize to the instantaneous frame of rest of the test particle. In this frame we can ignore the difference between coordinate and proper time, and γ s (since they are all equal to one). We will not recover a generally valid field equation in this way, but that is not our objective.

In the frame of instantaneous rest Eq. (A1) becomes:

$$\mathbf{F} = -\frac{d\mathbf{P}}{d\tau} = -\left(\frac{\partial m_0 c}{\partial t}, \mathbf{f}\right), \quad (\text{A4})$$

with,

$$\mathbf{f} = \frac{d\mathbf{p}}{dt}. \quad (\text{A5})$$

Since we seek the equation for the field (*i.e.*, force per unit mass) that produces \mathbf{F} , we normalize \mathbf{F} by dividing by m_0 . Defining $\mathbf{f} = \mathbf{F}/m_0$, we get,

$$\mathbf{F} = \frac{\mathbf{F}}{m_0} = -\left(\frac{c}{m_0} \frac{\partial m_0}{\partial t}, \mathbf{f}\right). \quad (\text{A6})$$

To recover a field equation of standard form we let the test particle have some small extension and a proper matter density ρ_0 . (That is, operationally, we divide the numerator and the denominator of the time-like factor of \mathbf{F} by a unit volume.) Eq. (A6) then is:

$$\mathbf{F} = -\left(\frac{c}{\rho_0} \frac{\partial \rho_0}{\partial t}, \mathbf{f}\right). \quad (\text{A7})$$

From SRT we know that $\rho_0 = E_0/c^2$, E_0 being the proper energy density, so we may write:

$$\mathbf{F} = -\left(\frac{1}{\rho_0 c} \frac{\partial E_0}{\partial t}, \mathbf{f}\right). \quad (\text{A8})$$

With an equation that gives the gravitational field strength that causes the inertial reaction force experienced by the test particle in hand, we next calculate the field equation by the standard technique of taking the divergence of the field strength and setting it equal to the local source. Note, however, that it is the *four-divergence* of the *four-field strength* that is calculated. To keep the calculation simple, this computation is done in the instantaneous rest frame of the test particle so that Lorentz factors can be suppressed. Since we will not be interested in situations where relativistic velocities are encountered, this simplification has no physical significance. The relativistic nature of this calculation turns out to be crucial, however, for all of the interesting behavior arises from the time-like part of four-forces (and their corresponding field strengths). The four-divergence of Equation (A8) is:

$$-\frac{1}{c^2} \frac{\partial}{\partial t} \left(\frac{1}{\rho_0} \frac{\partial E_0}{\partial t} \right) - \nabla \cdot \mathbf{f} = 4\pi G \rho_0. \quad (\text{A9})$$

Carrying out the differentiation with respect to time of the quotient in the square brackets on the LHS of this equation yields:

$$-\frac{1}{\rho_0 c^2} \frac{\partial^2 E_0}{\partial t^2} + \frac{1}{\rho_0^2 c^2} \frac{\partial \rho_0}{\partial t} \frac{\partial E_0}{\partial t} - \nabla \cdot \mathbf{f} = 4\pi G \rho_0. \quad (\text{A10})$$

Using $\rho_0 = E_0/c^2$ again:

$$-\frac{1}{\rho_0 c^2} \frac{\partial^2 E_0}{\partial t^2} + \left(\frac{1}{\rho_0 c^2} \right)^2 \left(\frac{\partial E_0}{\partial t} \right)^2 - \nabla \cdot \mathbf{f} = 4\pi G \rho_0, \quad (\text{A11})$$

We write the source density as $G\rho_0$, the proper *active* gravitational matter density. \mathbf{f} is irrotational in the case of our translationally accelerated test particle, so we may write $\mathbf{f} = -\nabla\phi$ in these particular circumstances, ϕ being the scalar potential of the gravitational field. Note that writing $\mathbf{f} = -\nabla\phi$ employs the usual sign convention for the gravitational field where the direction of the force (being attractive) is in the opposite sense to the direction of the gradient of the scalar potential. With this substitution for \mathbf{f} Eq. (A11) is:

$$\nabla^2\phi - \frac{1}{\rho_0 c^2} \frac{\partial^2 E_0}{\partial t^2} + \left(\frac{1}{\rho_0 c^2} \right)^2 \left(\frac{\partial E_0}{\partial t} \right)^2 = 4\pi G\rho_0. \quad (\text{A12})$$

This equation looks very much like a wave equation, save for the fact that the space-like part (the Laplacian) involves a scalar potential, whereas the time-like part (the time-derivatives) involve the proper rest energy density. To get a wave equation that is consistent with local Lorentz-invariance we must write E_0 in terms of ρ_0 and ϕ . Given the coefficient of $\partial^2 E_0 / \partial t^2$, only one choice for E_0 is possible:

$$E_0 = \rho_0 \phi. \quad (\text{A13})$$

Other choices do not affect the separation of variables needed to recover a relativistically invariant wave equation. But this is just the condition that follows from Mach's principle (and SRT). (Note that another sign convention has been introduced here; namely that the gravitational potential energy of local objects due to their interaction with cosmic matter is positive. This differs from the usual convention for the potentials produced by local objects, which are negative. Unless the cosmic matter is dominated by substance with "exotic" or negative mass, this convention must be simply imposed to replicate the fact that by normal conventions the rest energies of local objects are positive.)

Substituting $\rho_0 \phi$ for E_0 in Equation (A12) makes it possible to, in effect, separate the variables ρ_0 and ϕ to the extent at least that the d'Alembertian of ϕ can be isolated. Consider the first term on the LHS of Equation (A12) involving time-derivatives. Substituting from Equation (A13) into (A12) gives:

$$\begin{aligned} -\frac{1}{\rho_0 c^2} \frac{\partial^2 E_0}{\partial t^2} &= -\frac{1}{\rho_0 c^2} \frac{\partial}{\partial t} \left(\rho_0 \frac{\partial \phi}{\partial t} + \phi \frac{\partial \rho_0}{\partial t} \right) \\ &= -\frac{1}{c^2} \frac{\partial^2 \phi}{\partial t^2} - \frac{2}{\rho_0 c^2} \frac{\partial \phi}{\partial t} \frac{\partial \rho_0}{\partial t} - \frac{\phi}{\rho_0 c^2} \frac{\partial^2 \rho_0}{\partial t^2}. \end{aligned} \quad (\text{A14})$$

Making the same substitution into the second time-derivative term on the LHS of Equation (A12) and carrying through the derivatives produces:

$$\left(\frac{1}{\rho_0 c^2} \right)^2 \left(\frac{\partial E_0}{\partial t} \right)^2 = \left(\frac{1}{\rho_0 c^2} \right)^2 \left(\rho_0 \frac{\partial \phi}{\partial t} + \phi \frac{\partial \rho_0}{\partial t} \right)^2$$

$$= \frac{1}{c^4} \left(\frac{\partial \phi}{\partial t} \right)^2 + \frac{2\phi}{\rho_0 c^4} \frac{\partial \phi}{\partial t} \frac{\partial \rho_0}{\partial t} + \left(\frac{\phi}{\rho_0 c^2} \right)^2 \left(\frac{\partial \rho_0}{\partial t} \right)^2. \quad (\text{A15})$$

Now, taking account of the fact that $\phi/c^2 = 1$, we see that the coefficient of the second term on the RHS of this equation is $(2/\rho_0 c^2)$, so when the two time-derivatives are added the terms $(2\phi/\rho_0 c^4)(\partial\phi/\partial t)(\partial\rho_0/\partial t)$ will cancel. So the sum of these terms will be:

$$\left(\frac{1}{\rho_0 c^2} \right)^2 \left(\frac{\partial E_0}{\partial t} \right)^2 - \frac{1}{\rho_0 c^2} \frac{\partial^2 E_0}{\partial t^2} = -\frac{1}{c^2} \frac{\partial^2 \phi}{\partial t^2} - \frac{\phi}{\rho_0 c^2} \frac{\partial^2 \rho_0}{\partial t^2} +$$

$$+ \left(\frac{\phi}{\rho_0 c^2} \right)^2 \left(\frac{\partial \rho_0}{\partial t} \right)^2 + \frac{1}{c^4} \left(\frac{\partial \phi}{\partial t} \right)^2. \quad (\text{A16})$$

When the first term on the RHS of this equation is combined with the Laplacian of ϕ in Equation (A12) one gets the d'Alembertian of ϕ and the classical wave equation (A17) below is recovered.

$$\nabla^2 \phi - \frac{1}{c^2} \frac{\partial^2 \phi}{\partial t^2} = 4\pi G \rho_0 + \frac{\phi}{\rho_0 c^2} \frac{\partial^2 \rho_0}{\partial t^2} - \left(\frac{\phi}{\rho_0 c^2} \right)^2 \left(\frac{\partial \rho_0}{\partial t} \right)^2 - \frac{1}{c^4} \left(\frac{\partial \phi}{\partial t} \right)^2. \quad (\text{A17})$$

The remaining terms that follow from the time-derivatives of E_0 in Equation (A16) then become transient sources of ϕ when its d'Alembertian is made the LHS of a standard classical wave equation. That is, we have recovered Equation (6) above.

APPENDIX B

There may be those unconvinced by this argument, for in the case of the “rocket equation” $\mathbf{v} dm/dt$ seems to be treated as a real force. But brief reflection on the “rocket” case reveals that this is not strictly speaking correct and, moreover, there is an important difference between the “rocket” case and the situation involving “impulse engines” discussed here. Recall the circumstances of the elementary “rocket equation”. A rocket of mass M experiences an acceleration \mathbf{a} as a result of the expulsion of propellant at a rate dm/dt with an *invariant* velocity \mathbf{v} with respect to the rocket. (We work in the Newtonian limit here where Galilean invariance is all that is required.) Since the total “force” on the system is zero, we have:

$$\mathbf{F} = M\mathbf{a} + \mathbf{v} \frac{dm}{dt} = 0, \quad (\text{B1})$$

from which it immediately follows that,

$$M\mathbf{a} = -\mathbf{v} \frac{dm}{dt}, \quad (\text{B2})$$

and the acceleration of the rocket due to the “thrust” of the propellant is:

$$\mathbf{a} = -\frac{\mathbf{v}}{M} \frac{dm}{dt}. \quad (\text{B3})$$

It is easy to believe, since \mathbf{a} is proportional to dm/dt , that \mathbf{a} is *caused* by dm/dt . But this is not correct. \mathbf{a} is actually caused by the momentum reflection of half of the combustion products of the propellant by the forward wall of the combustion chamber. It is the direct contact action of the momentum reversal of the propellant – the $M\mathbf{a}$ term that is – that causes the rocket to accelerate. The $\mathbf{v}dm/dt$ term does not describe this force; it merely records the rate at which momentum is added to that already present in the exhaust plume of the rocket – something that must be done to properly account for momentum conservation in any event.

In addition to the $\mathbf{v}dm/dt$ term in the “rocket equation” not describing the actual acceleration of the rocket caused by the force created by momentum reversal of the propellant in the combustion chamber, another important point should be noted. Equations (B1) through (B3) are *instantaneously* applicable. That is, if combustion of fuel is stopped and $M\mathbf{a}$ immediately goes to zero, so too does $\mathbf{v}dm/dt$. One cannot have these two terms be different at the same time, but “average out” over some extended time (which might be one cycle of a cyclic process). In quantum systems one might get away with this; but not in a strictly considered classical system. (This, after all, is the reason why momentum is associated with, for example, the electromagnetic field.)

To make plain the difference between rockets and “impulse engines”, consider the device in Figure 1 operated in the following way. Each cycle of operation is broken up into four parts. During the first part of the cycle, a voltage signal is applied to the device so as to produce a stationary mass increase in the FM (by arranging dP/dt to be constant). While this takes place, the actuator expands so that the FM suffers acceleration \mathbf{a} . During this part of the cycle the RM, owing to the inertial reaction force \mathbf{F} communicated through A to it, experiences an impulse $\Delta\mathbf{p}$:

$$\Delta\mathbf{p} = \int \mathbf{F} dt = -\int (m + \delta m) \mathbf{a} dt = -(m + \delta m) \mathbf{a} \Delta t, \quad (\text{B4})$$

where \mathbf{a} of the FM is taken positive when A expands. In the second part of the cycle A is manipulated so as to keep the velocity of the FM constant while its mass is changed from $m + \delta m$ to $m - \delta m$. In the third part of the cycle A accelerates the FM in this mass-reduced state so as to reverse the velocity of the FM relative to the RM, imparting an impulse, via the inertial reaction force on the RM,

$$\Delta\mathbf{p} = \int \mathbf{F} dt = \int (m - \delta m) \mathbf{a} dt = (m - \delta m) \mathbf{a} \Delta t, \quad (\text{B5})$$

to the RM. The sum of these impulses generated while the mass of the FM is held constant (at different values) is:

$$\Delta\mathbf{p} = -2\delta m \mathbf{a} \Delta t. \quad (\text{B6})$$

The RM, accordingly, experiences this impulse from the parts of each cycle where A produces a force between it and the FM.

In the fourth part of the cycle the mass is changed from $m - \delta m$ to $m + \delta m$ while the FM moves at constant velocity. This is just the reverse of the circumstances in the second part of the cycle. Now we must deal with the $\mathbf{v}dm/dt$ “force”. This only acts during two parts of the cycle when the FM is moving, by design, with constant velocity $\pm\mathbf{v}$. That velocity will be equal to \pm

$\mathbf{a}\Delta t/2$ after continuous cyclic behavior is established. This force presumably acts on the FM, so as A is expanding:

$$\Delta \mathbf{p} = \int \mathbf{v} \frac{dm}{dt} dt = -\mathbf{v} 2\delta m = -\mathbf{a}\Delta t \delta m . \quad (\text{B7})$$

When the part of the cycle where A is contracting occurs, the signs of \mathbf{v} and dm/dt both reverse, so the contribution of that part of the cycle is the same as the expansion part. The sum of these two parts is:

$$\Delta \mathbf{p} = -2\delta m \mathbf{a} \Delta t . \quad (\text{B5})$$

If the “force” producing this impulse generated an equal and opposite impulse on the reaction mass, then the $m\mathbf{a}$ and $\mathbf{v}dm/dt$ impulses would cancel each other out, and no net momentum would occur in the RM over a complete cycle. But this cannot be the case, for if a mass fluctuation is produced in capacitors in an inertial frame where they are at rest, they do not spontaneously accelerate as the mass fluctuation takes place.

Only if the mass fluctuation is engineered to produce a *directed* momentum flux, in this case, in the gravinertial field, will there be a force on the FM that is communicated through A to the RM. Absent such engineering, the RM acquires a $-2\delta m \mathbf{a} \Delta t$ momentum impulse in each cycle. This may seem a violation of local momentum conservation, but we have not allowed for the momentum carried by the gravinertial field to/from the FM during the parts of the cycle when $dm/dt \neq 0$ and $\mathbf{v} = \mathbf{a} t$, which *must* supply the difference. In other words, just as the $\mathbf{v}dm/dt$ term in the “rocket equation” takes account of the rate of change of momentum in the exhaust plume – which itself does not exert any force on anything – in this case the $\mathbf{v}dm/dt$ term takes account of the rate of momentum transfer to/from the FM as the mass changes due to the Mach effect mass fluctuation – which likewise does not exert any force directly on any part of the system. Should any doubt about this remain, the experiment described in this paper tests both for the presence of Mach effect mass fluctuations *and* the correctness of this analysis of momentum transfer in flux capacitor systems. Should either part of this analysis turn out to be wrong, no thrust should be detected with the device used in the experiment described herein.