

From Optics &  
Photonics News

# **Non-Interaction of Waves (NIW): Applications in Astrophysics**

**(The modified ether, as the stationary Complex Tension Field, or  
CTF, can be the foundation of a possible unified field theory.)**

**ChandraSekhar Roychoudhuri**

**Physics Department, University of Connecticut, Storrs, CT 06269**

**October 6, 2017**

# Summary

Modern physics systematically ignores a very basic phenomena in wave propagation. The waves are linear excitations of some tension field. So they pass through each other without re-organizing each others' propagation energy. Each wave front continues to propagate through others following the evolution principle of their own Poynting vectors. This Non-Interaction of Waves (NIW) have deep ramifications in all of physics.

- For EM waves, the space needs to be a stationary Complex Tension Field (CTF) to have the same velocity “ $c$ ” everywhere. CTF is the old ether with some new physical properties. Particles are localized doughnut-like self-looped vortices. This takes care of the following: (i) The “null-drag” (Michelson Morley experiments) should be the norm between matter and CTF.
- (ii) The energy is always conserved (held by the CTF) but can change the its forms between propagating waves and different kinds of particles. 100% of the energy always remains in the CTF.
- (iii) Thus, the EM waves and particles are the same kinds of undulations everywhere in space, around all stars and galaxies. That is why all physics principle of nature holds everywhere and spectral properties are identical everywhere for the same elements.
- (iv) The real Doppler frequency shift of light emitted by atoms can be differentiated from apparent Doppler shift of light frequencies perceived by detectors moving with different velocities.
- (v) Cosmological Redshift should explained as due to the dissipative properties of the CTF. It is not due to Doppler effect. (vi) So the absolute velocities of stars and galaxies should be measurable using moving rocket-based spectrometer.

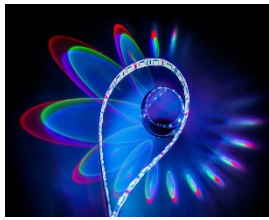

*From Optics &  
Photonics News.*

# How to think!

**Reverse system engineering thinking has been the most enduring approach since the beginning of human evolution.**

# We are all “blind”

The classic allegorical story.

! No sensor can gather all the relevant information ever !  
!! Evidence based science is always incomplete !!



We must iterate, iterate, iterate, ....., our working theories from the very foundations.

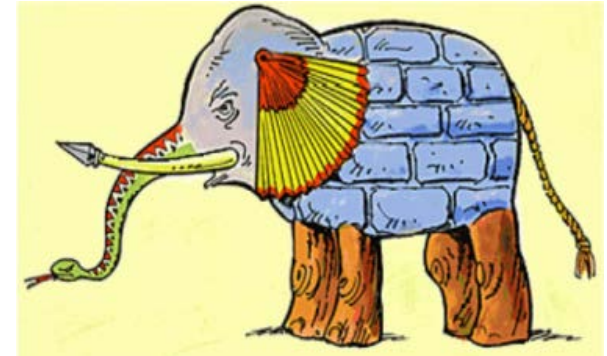
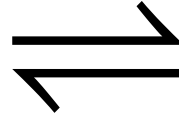

- Gather diverse input.
- Visualize conceptual continuity among them.
- Refine the concept by imposing logical congruence between many observations.
- Iterate the theories forever.
- There are no final theories.

## Evolutionary Process- Congruent Thinking

1. **Nature is the most creative system engineer.**
2. **We need to be reverse system engineering thinkers to understand nature.**
3. **Modern physics thinking does not explicitly recognize this critical issue.**

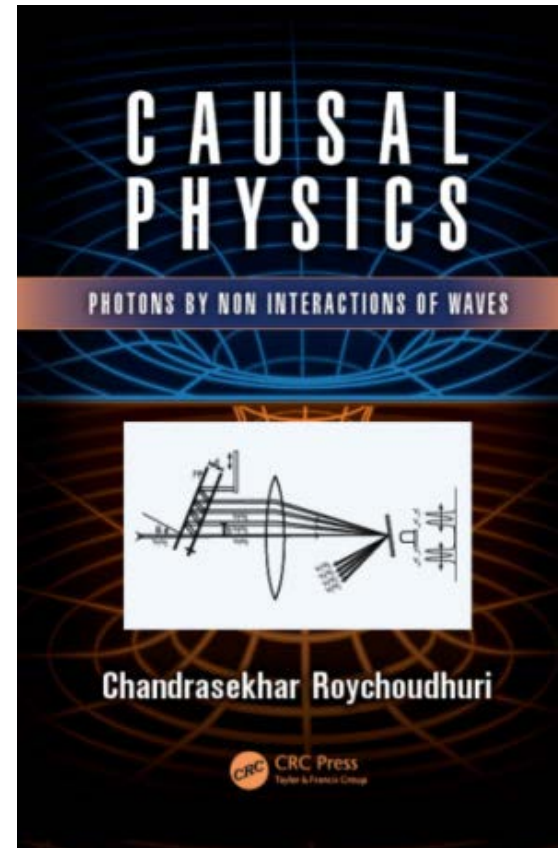



**Appreciating NIW  
as a routine phenomenon:-**

- 1. Down on earth,**
- 2. And, in space.**

**Waves (*excitation*) of water surface-tension field pass through each other without interacting.**



Appreciation: (i) Michael Ambroselli, my PhD student, for video recording and processing.

# Waves (*excitation*) of mechanical spring-tension field pass through each other without interacting

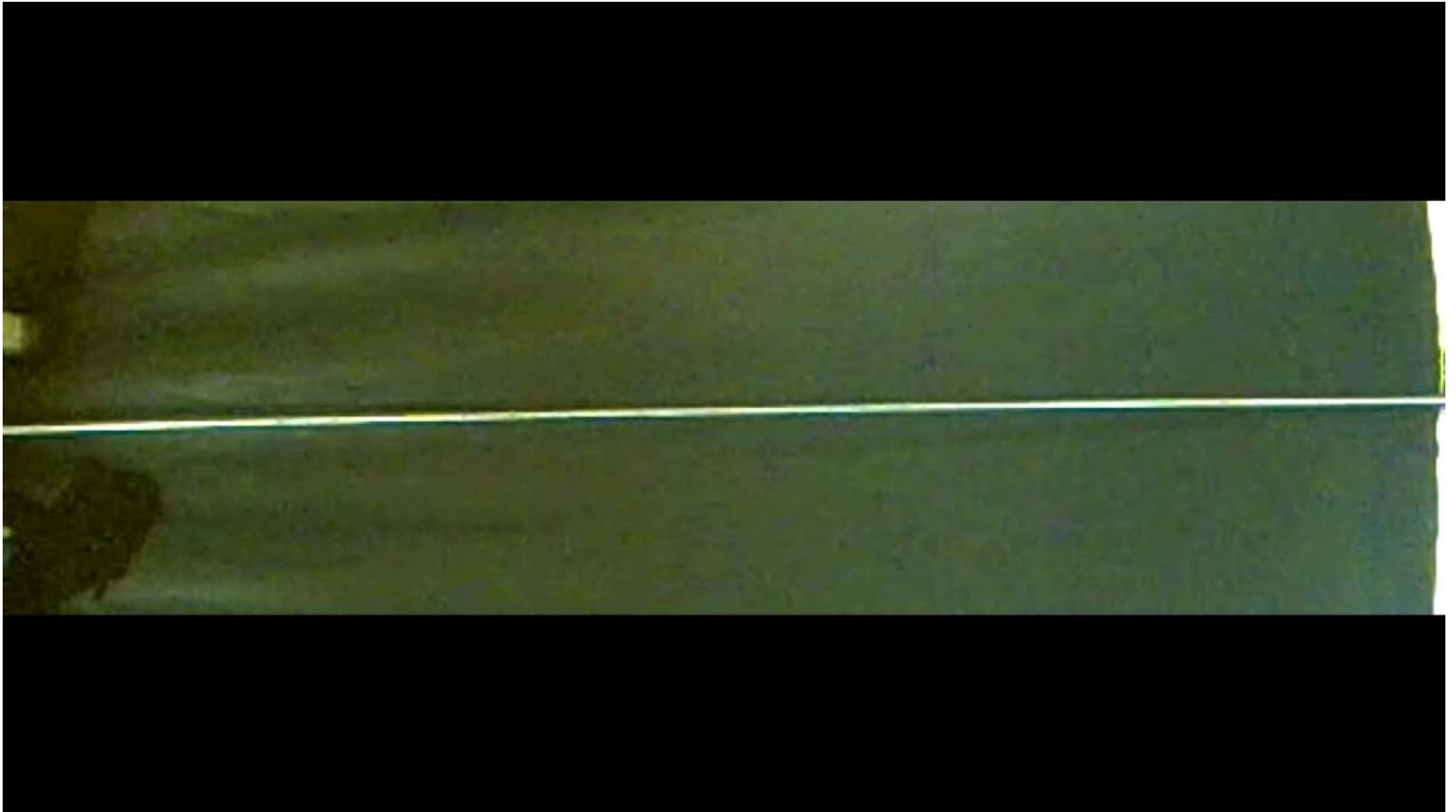

Appreciation: (i) David Park, a high school student for diverting me to use spring instead of rope. (ii) Michael Ambroselli for video recording and processing.



# For light, NIW was also known since ancient times!

**Ibn al-Haytham (Alhazhen), a major physicist (965-1040) of the Arab world.**

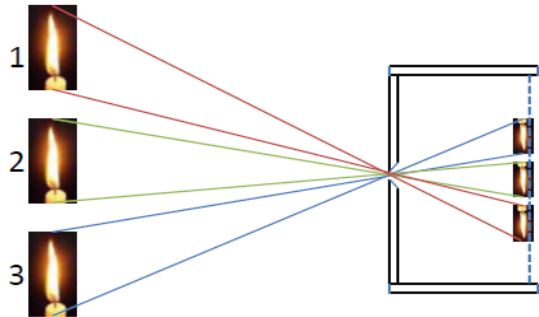
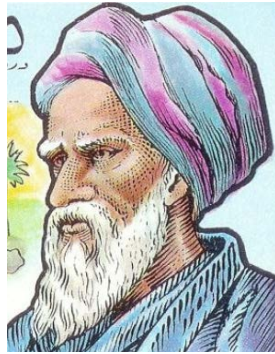

Alhazen, using an array of candles and a pin-hole camera, experimentally demonstrated that light beams cross through each other without destroying any information they are carrying.

**Christian Huygens (1629-1695)**

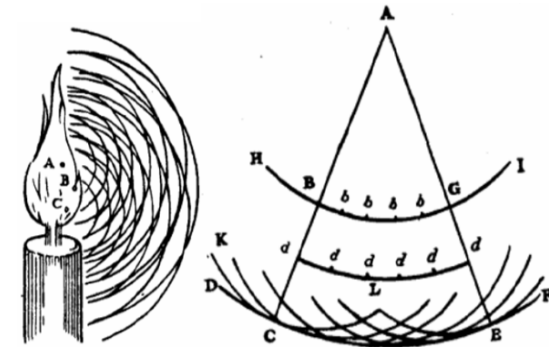

Huygens clearly wrote in his 1690 book that waves evolve by spreading diffractively through each other without altering each other physical properties.

EM waves (*excitation*) of Complex Tension Field (CTF) are passing through each other unperturbed from all corners of the cosmic space with the same perpetual and constant velocity “c” for 13.5 billion years!



**Hubble Deep Field** HST - WFPC2  
PRC96-01a - ST ScI OPO - January 15, 1996 - R. Williams (ST ScI), NASA

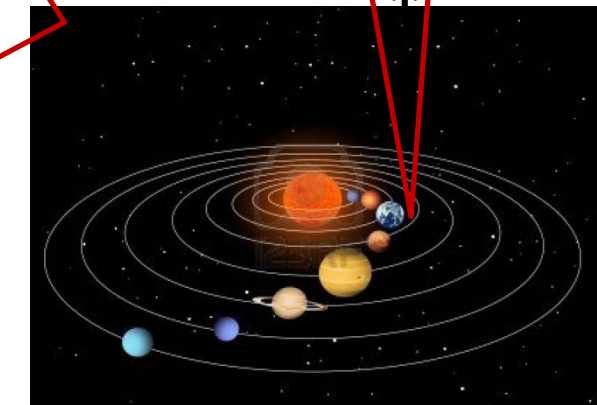

**Astrophysics observational data are reproducible because of the NIW property of EM waves.**

**NIW and the Linearity, are  
built into the wave equation.  
They are inseparable!**

# Deriving EM wave equation as per classical string wave model assuming CTF possesses electric & magnetic tensions.

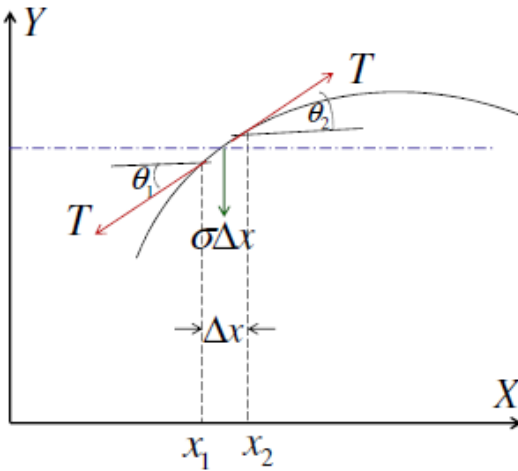

## Classical string wave derivation:

The wave equation for a string under tension is derived by equating two balancing forces. Inertia times acceleration of an elemental string length equals the restoring tension force. Displacement of string position is “y”.

$$ma = F$$

$$\sigma \Delta x \frac{\partial^2 y}{\partial t^2}(x, t) = \Delta_x (T \sin \theta) \approx T \Delta_x \left( \frac{\partial y}{\partial x} \right)$$

→ **Inertial resistance to material movement.**

$$\sigma \Delta x \frac{\partial^2 y}{\partial t^2}(x, t) = T \Delta_x \frac{\partial y}{\partial x} \Rightarrow \frac{\partial^2 y}{\partial t^2}(x, t) = \frac{T}{\sigma} \frac{\partial}{\partial x} \frac{\partial y}{\partial x}(x, t) = v^2 \frac{\partial^2 y}{\partial x^2}(x, t)$$

$$\frac{\partial^2 y}{\partial t^2} = v^2 \frac{\partial^2 y}{\partial x^2}; \quad v^2 \equiv T / \sigma$$

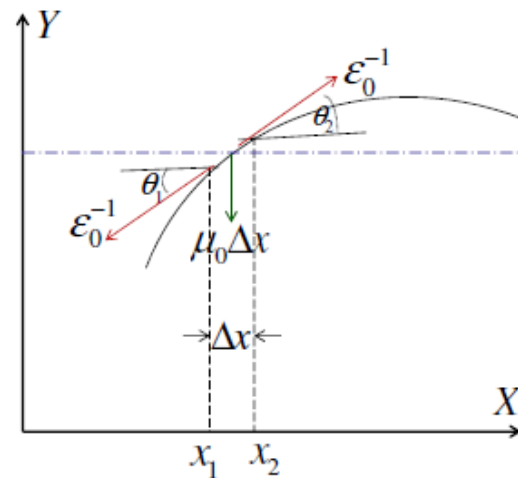

## EM wave derivation as per string model:

The wave equation for “vacuum” under tension is derived by equating two balancing forces. Mass times acceleration of an elemental string length equals the restoring tension force. Displacement of string position is “y”.

$$ma = F$$

$$\mu_0 \Delta x \frac{\partial^2 y}{\partial t^2}(x, t) = \Delta_x (\epsilon_0^{-1} \sin \theta) \approx \epsilon_0^{-1} \Delta_x \left( \frac{\partial y}{\partial x} \right)$$

→ **Inertial resistance to generate magnetic field.**

$$\mu_0 \Delta x \frac{\partial^2 y}{\partial t^2}(x, t) = \epsilon_0^{-1} \Delta_x \frac{\partial y}{\partial x} \Rightarrow \frac{\partial^2 y}{\partial t^2}(x, t) = \frac{\epsilon_0^{-1}}{\mu_0} \frac{\partial}{\partial x} \frac{\partial y}{\partial x}(x, t) = c^2 \frac{\partial^2 y}{\partial x^2}(x, t)$$

$$\frac{\partial^2 y}{\partial t^2} = c^2 \frac{\partial^2 y}{\partial x^2}; \quad c^2 \equiv \epsilon_0^{-1} / \mu_0$$



## **Removing wave-particle duality.**

**Particles are localized self-looped and resonant  
doughnut-like oscillations of CTF.**

# Does $\psi$ really represent the “Abstract Mathematical Probability (Pilot) Wave? Or, is it a real a physical oscillatory amplitude of some field-gradient?

All these harmonic undulations can be expressed by the same exponential function:

$$a \exp(i\omega t) \equiv a \exp(i2\pi vt) = a \exp(iEt / \hbar); \text{ with the postulate : } E = hv$$

Diagrams adapted from web

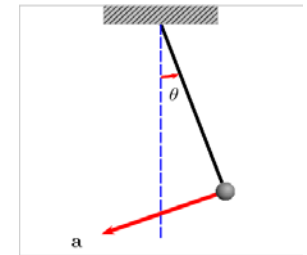
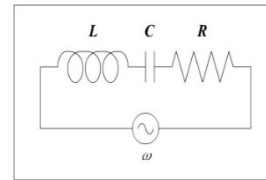
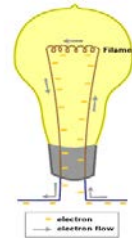
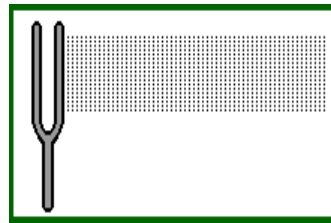
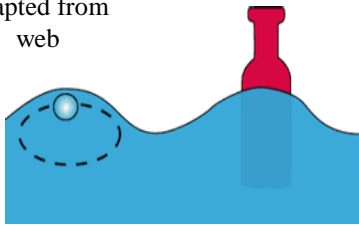

If the particles are localized resonant oscillations of the vacuum (Complex tension Field, or CTF; then Schrodinger's “wave function” represents real physical harmonic excitations rather than various abstract mathematical probability amplitudes as “Pilot or plane waves”.

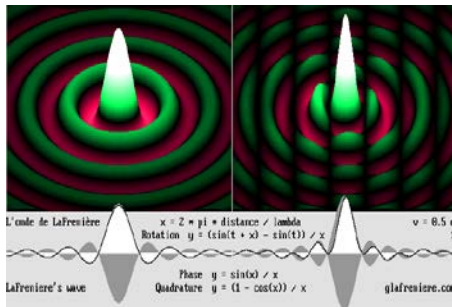

## SCHRODINGER

$$i\hbar \frac{\partial \psi}{\partial t} = \left( \frac{p^2}{2m} + V \right) \psi = H\psi$$

Mathematical plane wave does not exist in the real world !

❖ *Wave-particle duality started as “lack of detailed knowledge”. It is not a new definitive knowledge.*

**Then, what are particles?**  
**They are also oscillations of the same CTF!**

Particles are localized resonant oscillations of other component tension fields of the same CTF. The oscillations are most likely self-looped doughnut-like to acquire their “localized” properties. These are not De Broglie's Pilot Waves guiding the material particles existing independent of CTF.

Particles have internal oscillations (energy) that determines their very existence, which is already captured by Schrodinger's expression for free particle:

$$\psi_{in} = e^{-i(^{in}E)t/\hbar} = e^{-i(^{in}f)t}; \quad \text{where } ^{in}E = h (^{in}f)$$

I am hypothesizing that particles acquire a different kind of external oscillation frequency as they kinetic motion and energy while “falling” into potential gradients produced in the CTYF by other particles. There are no force. There are only potential gradients generated in the CTF due to the localized oscillations of particles.

$$\psi_k = e^{-i(^kE)t/\hbar} = e^{-i(^kf)t}; \quad \text{where } ^kE = h (^kf)$$

Notice that the kinetic energy can be related to the particle mass and velocity and hence a fictitious De Broglie wavelength. For zero velocity, the De Broglie wave length is infinite; but the kinetic frequency is zero (well defined):

$$^kE = mv^2 / 2 = h (^kf) \quad (^k\lambda)(^kf) = v \Rightarrow (^k\lambda) = v / (^kf) = hv/(mv^2 / 2) = 2h / p$$

**Waves and particles, both are emergent excited states  
of CTF of certain energy; which is still held by CTF.**



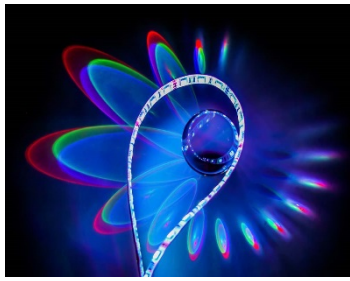

# **Appreciating the impact of NIW in all branches of physics**

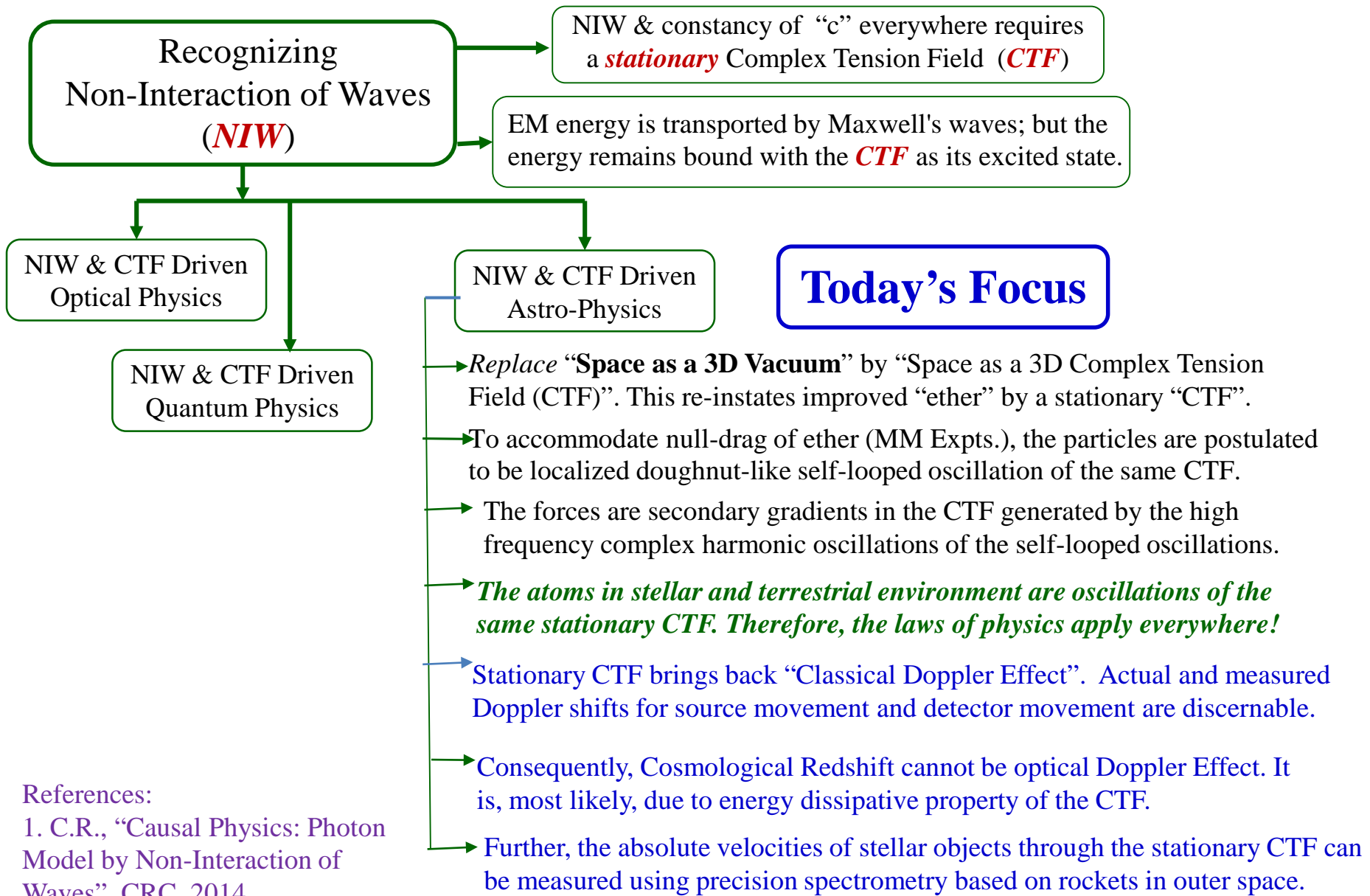

References:

1. C.R., “Causal Physics: Photon Model by Non-Interaction of Waves”, CRC, 2014.
2. Download papers from the website accessible through the department.

# Impact of Non-Interference (non-interaction) of Waves (NIW)

## Impacts in Classical Physics

1. **Spectrometry:** The resolution limit  $\delta\nu\delta t \geq 1$  is not a principle of nature.
2. **Coherence:** Waves are never incoherent. Visibility (correlation) is determined by the time constant of the detecting system.
3. **Polarization:** NIL implies superposition of orthogonally polarized beams cannot generate elliptically rotating E-vector.
4. **Mode locking:** A laser pulse is generated by “time gating” of saturable absorber, not locking of modes
5. **Pulse broadening:** Is due to time diffraction, not due to dispersion of Fourier frequencies.
6. **Fourier transform & light beating spectroscopy** determine real carrier frequencies, not Fourier frequencies.

## Impact in mathematical framing of physics problems

Mathematical operating symbols should be carefully tied with transformational interactions

The time-frequency Fourier theorem is not a principle of nature!  
No natural interactions create Fourier frequencies out of a pulse nor create a pulse out of Fourier frequencies.

Wiener-Khintchine theorem – Fourier spectral density and autocorrelation functions form a “Fourier transform pair” – is based on non-interference of Fourier sinusoids!

More to come!

## Impact in Quantum Physics

1. Photons are divisible & summable in light-matter interactions.
2. Dirac’s “photons” do not conform to causality & energy conservation
3. Classical photon as an exponential wave packet conforms to quantum predictions:  $\Delta E_{mn} = h\nu_{mn}$
4. A photon cannot interfere with itself. “Which way?” photon travels, is a meaningless question.
5. Bell’s Inequality theorem is inapplicable to superposition effects due to photons.
6. Indivisible entangled single photon interference does not exist

## The NIW-property enhances the conceptual foundation of physics

1. Replace Einstein's "**indivisible quanta**" by Planck's divisible classical wave packet, while energies of photo electrons are quantized.
2. Replace Dirac's "**A photon interferes only with itself**", by "A detector's simultaneous stimulations due to multiple excitations, create superposition effect".
  3. Replace Dirac's photon as a "**Fourier mode of the vacuum**" by "Classical wave packet of the "Complex Tension Field (CTF)".
  4. Replace "**Space as Vacuum**" by "Space as Complex Tension Field (CTF)". Re-instate improved "ether" by "CTF".
  5. Replace Born's interpretation of  $\Psi$  as "**mathematical probability amplitude**" by physical stimulation of internal structure of particles.
    6. Drop "**Bell's In-equality theorem**" as it does not map Superposition Effect and re-instate "EPR Reality & Locality".
  7. Replace "**Uncertainty Principle**" by "information retrieval problem"
8. Replace "**Relativistic Doppler Effect**" by "Classical Doppler Effect". Actual and measured Doppler shifts are different for source movement and detector movement. Drop "**Expanding Universe**" by "Stationary Universe".
  9. Replace de Broglie's "**pilot wave**"  $\lambda = h / p$  [ $\rightarrow \infty$  for  $v = 0$ ], by internal harmonic frequency proportional to its kinetic energy.
10. Replace "**wave-particle duality**" by separate realities for waves and for particles.
11. Replace "**4-D Space**" by "3-D Space" since running time is not measurable physical attribute of anything in this universe; frequency is.

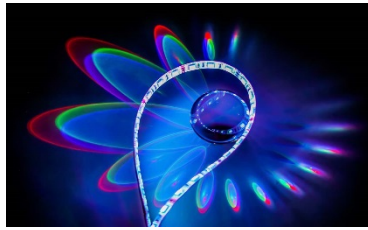

## **Appreciating deeper physical processes behind Doppler Effects**

- ❖ **The physical processes behind the spontaneous & the stimulated emissions, in a gas laser, tell us that source & detector velocities are discernible for actual & apparent Doppler Shifts!**
- ❖ **Optical Doppler effect is not determined by the source-detector relative velocity only, albeit mathematically correct!**

# Example of real Doppler shift: Effect of atom (source)-velocity on spontaneous emission frequencies

Maxwell-Boltzmann velocity distribution; number of molecules with velocity  $v$  and  $v+dv$  :

$$df(v) = (M / 2\pi kT) e^{-Mv^2/2kT} dv$$

Replace  $V_{src.}$  by Doppler shifted frequency, while keeping track of source, or, quantum emission frequency:

$$\begin{aligned} \text{det. } v &= \text{mn } v (1 \mp v_{src.} / c)^{-1} \\ &= \text{mn } v (1 \pm v_{src.} / c) + 2\text{nd \& higher order terms} \end{aligned}$$

$$\text{Or, } v_{src.} = (c / \text{mn } v) (\text{det. } v - \text{mn } v)$$

Corresponding Doppler broadened spectrum and the Doppler half-width are given by:

$$S_{Dop.}(v) = \frac{1}{D. \delta v} \left( \frac{4 \ln 2}{\pi} \right)^{1/2} e^{-4(\text{det. } v - \text{QM } v) (\ln 2 / D. \delta v)^2}$$

$$D. \delta v = \left( \frac{2kT}{M} 4 \ln 2 \right)^{1/2} (\text{QM } v / c)$$

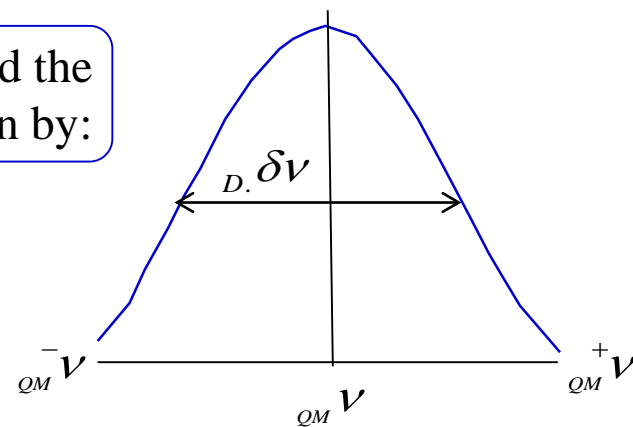

Measurable physical Spectrum

Note that classical and quantum physics are merged into one physics!

**The QM transition frequency is unaffected; but the evolved photon wave packets emerge with different frequencies due to thermal velocity of atoms**

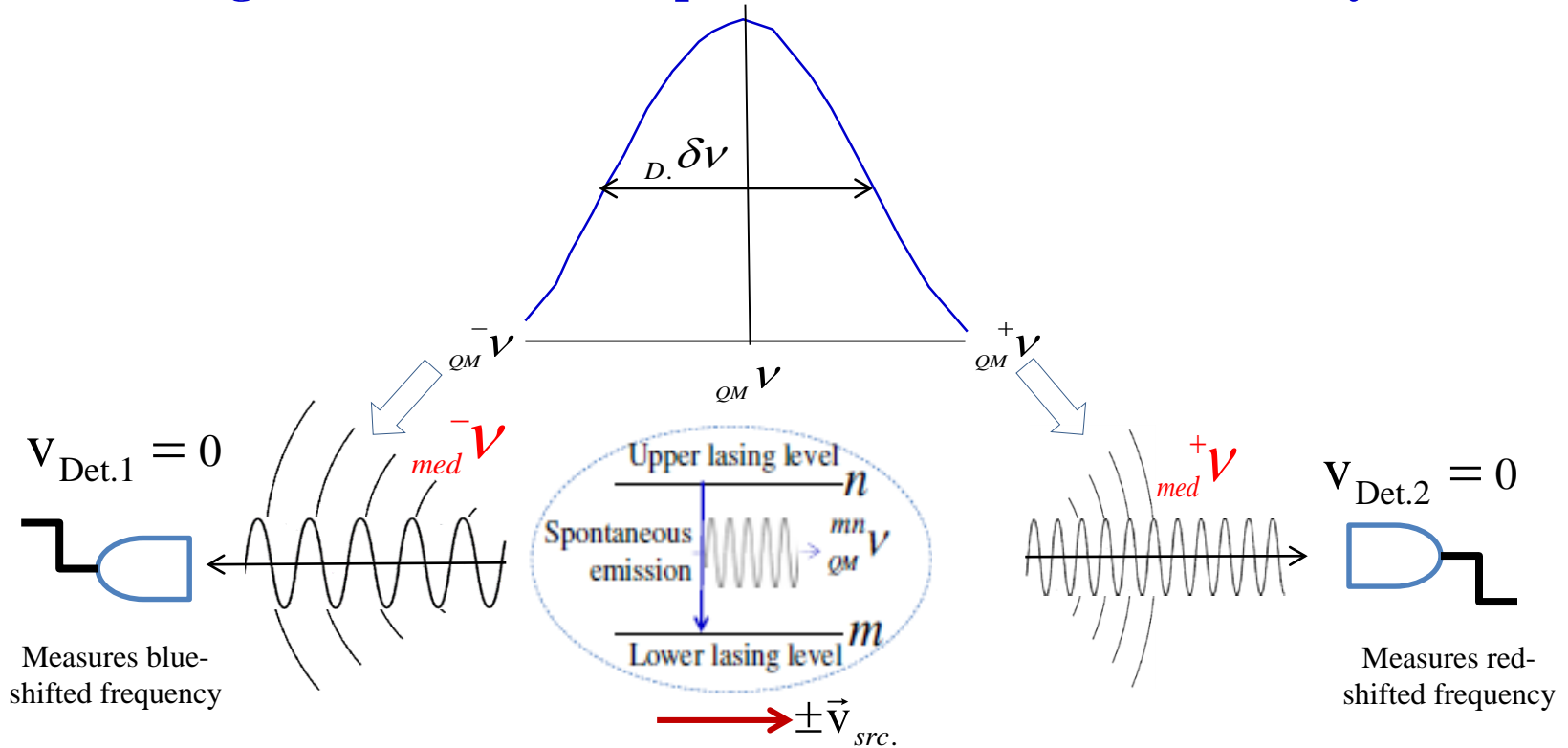

**Eq.1**

$$\pm v_{det.} \equiv \pm v_{med.} = \frac{v_{QM}^{mn}}{1 \mp v_{src.} / c} = v_{QM}^{mn} (1 \mp v_{src.} / c)^{-1}$$

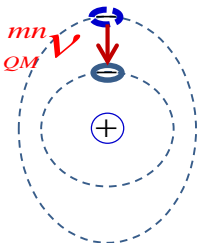

**Assumption:** For thermal velocities, QM transition frequencies remain unaltered. Then the “vacuum” as a tension field, promotes real physical frequency shifts, as in the case for sound.

# Real Doppler frequency shift measurement: Only source moves

Spectral analysis of spontaneous emissions from Ne-atoms from a He-Ne laser discharge tube

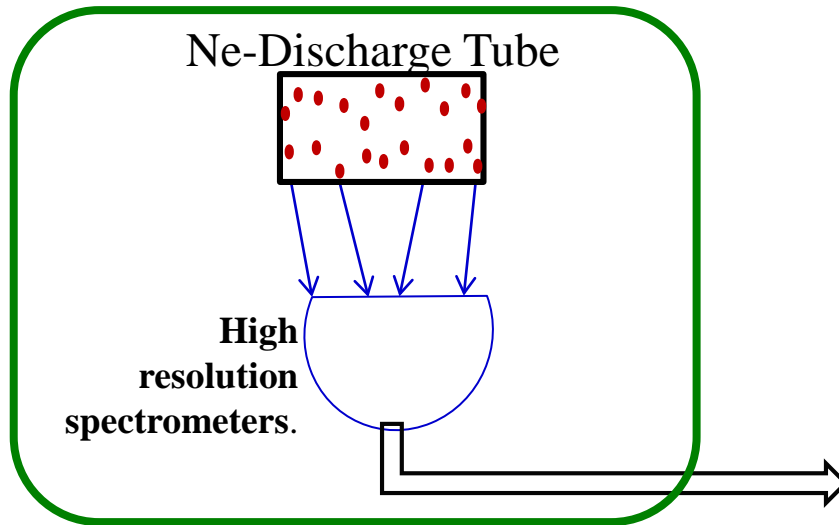

**Same reference frame.  
Zero relative velocity  
between the  
spectrometer and the  
discharge tube**



# Real Doppler frequency shift measurement: Only source moves

Spectral analysis of spontaneous emissions from Ne-atoms from a He-Ne laser discharge tube

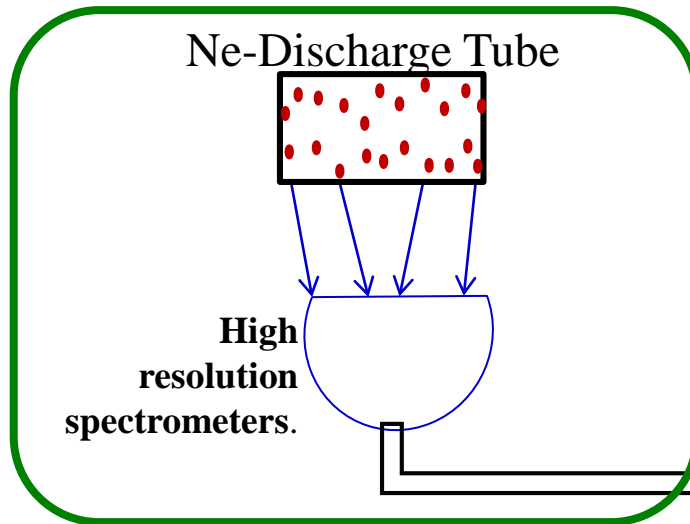

**Same reference frame.  
Zero relative velocity  
between the  
spectrometer and the  
discharge tube**

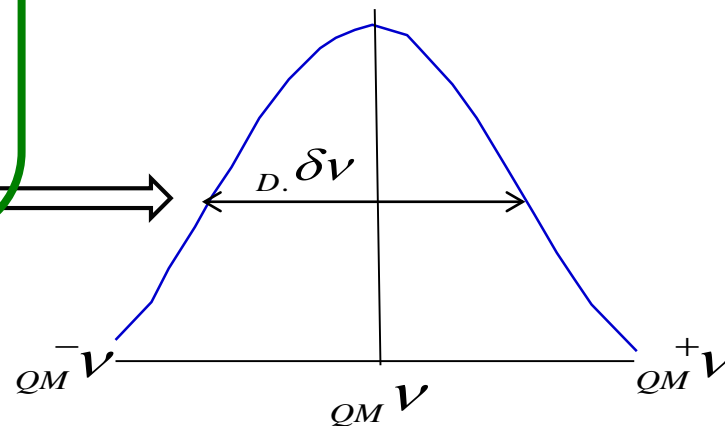

**1.5 GHz Doppler broadened  
spontaneous emission spectrum**

# Different *perceived* frequencies by detectors when they move with respect to the “vacuum”

**Detectors move with different velocities in the medium.** The source is stationary.

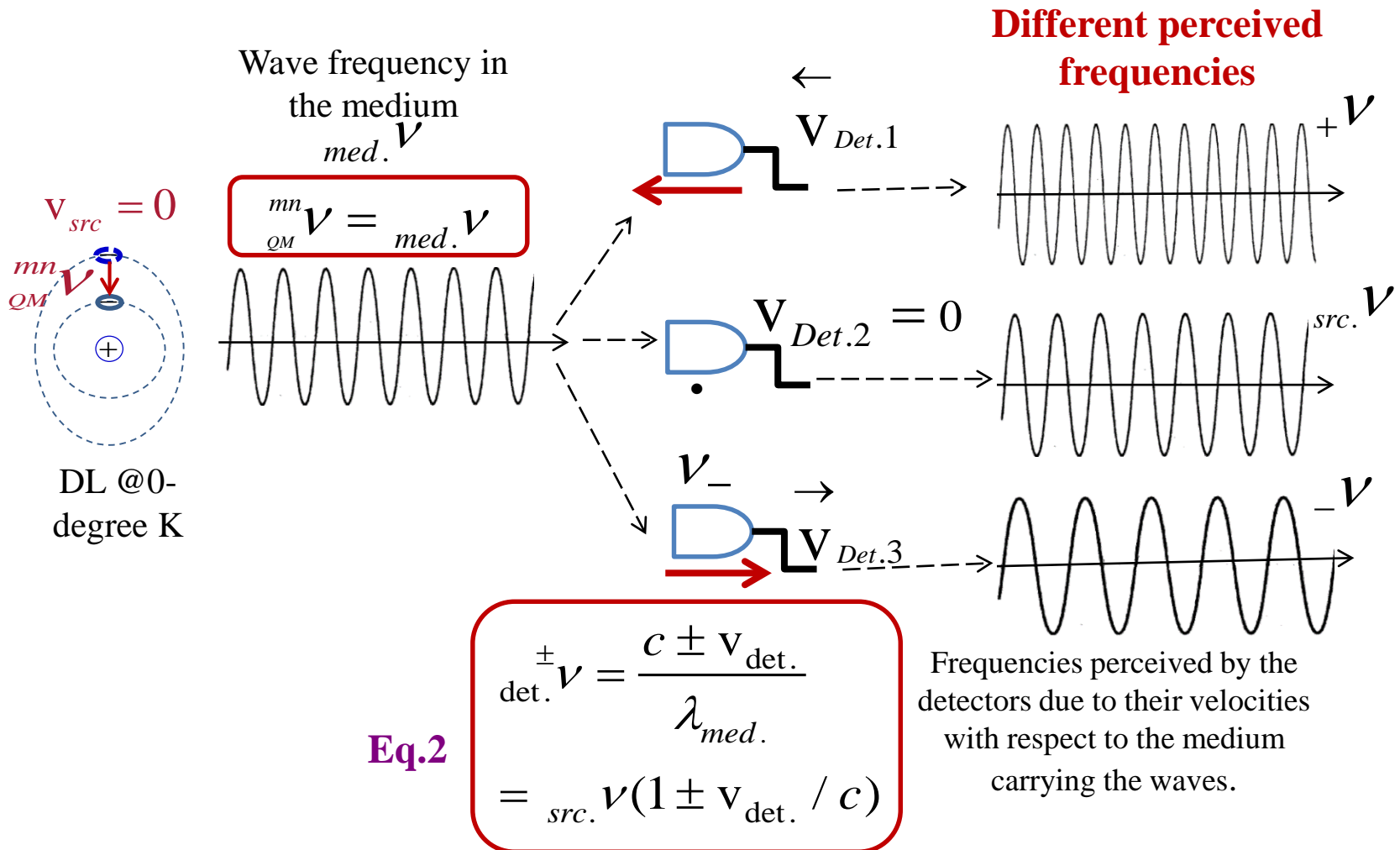

# Both the source and the detectors move with respect to the stationary medium

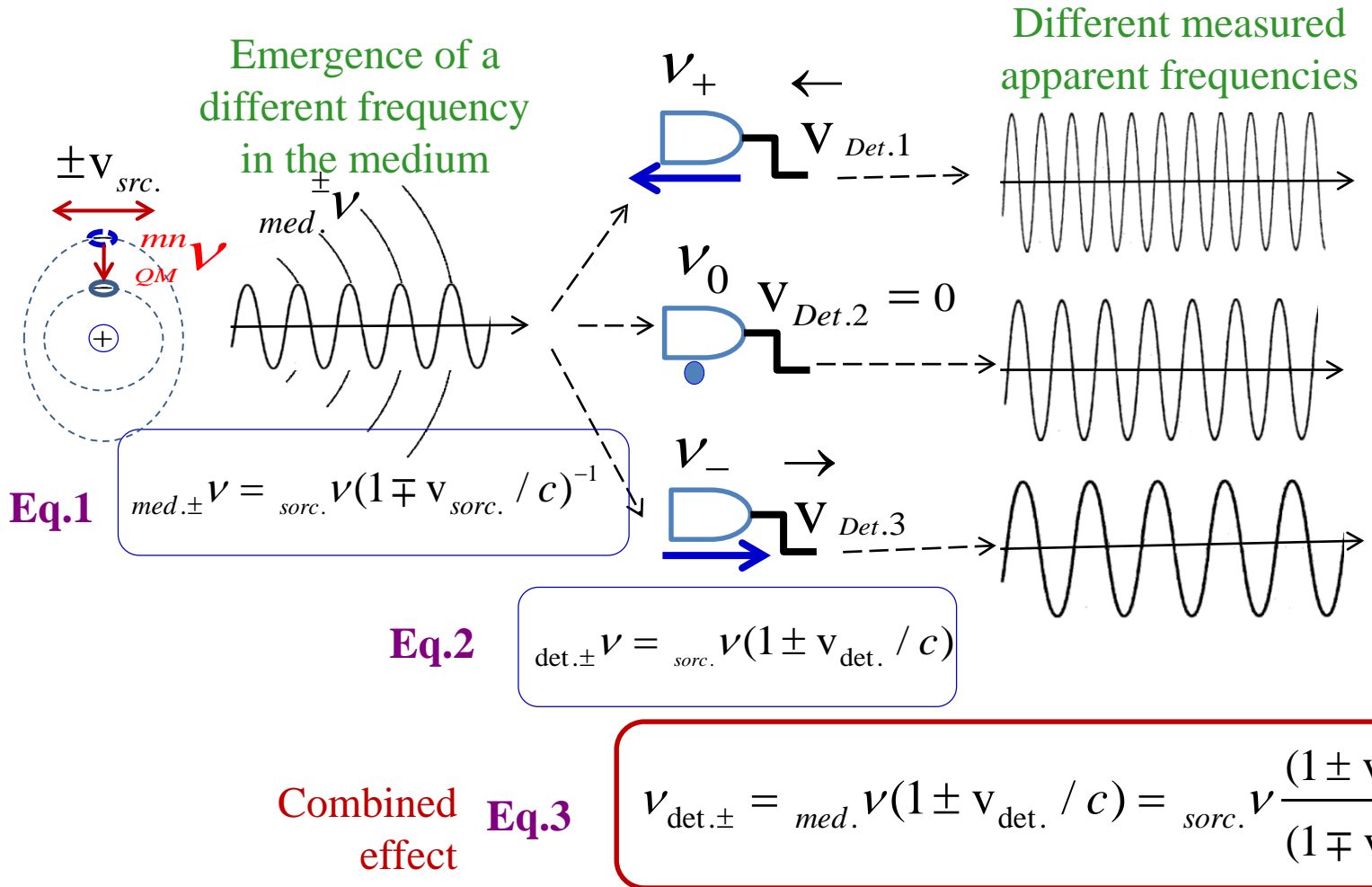



## **Appreciating deeper physical processes behind Doppler Effects**

- ❖ The physical processes behind the spontaneous & the stimulated emissions tell us that source & detector velocities are discernible for actual & apparent Doppler Shifts!**

**Stellar & earthly, emission & absorption, Doppler broadened spectrometry tell us that the source and detector velocities are clearly discernible!**

Spontaneous emission individual events

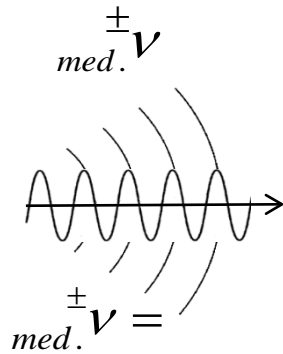
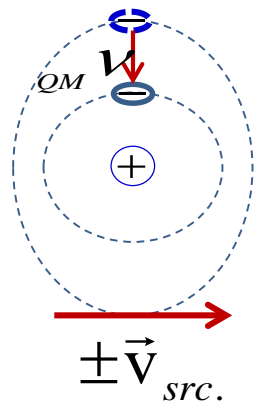

$$med. v = v_{src.} (1 \mp v_{src.} / c)^{-1} \quad \text{Eq.1}$$

Distribution

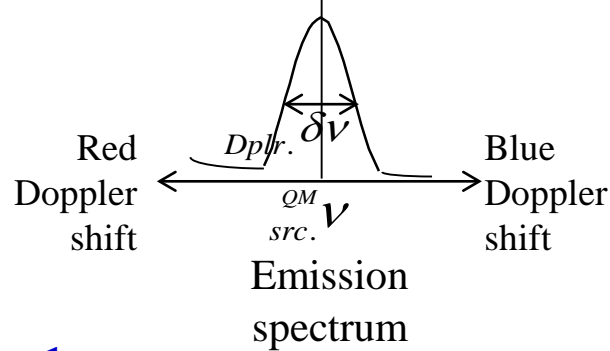

The light emitting atoms could be from a star or from a lab lamp.

Stimulated absorption individual events

“White light”

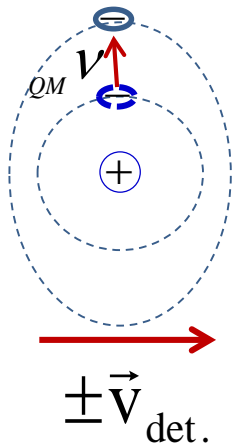
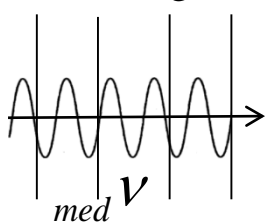

$$med. v = v_{det.} (1 \pm v_{det.} / c) \quad \text{Eq.2}$$

Distribution

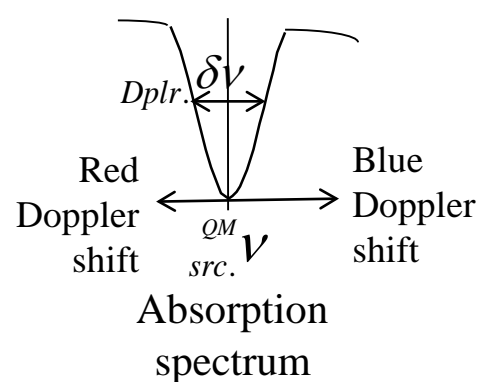

The light absorbing atoms could be in a star or in a lab tube.

# Spontaneous & stimulated emissions tell source & detector velocities are discernible for actual & apparent Doppler Shifts!

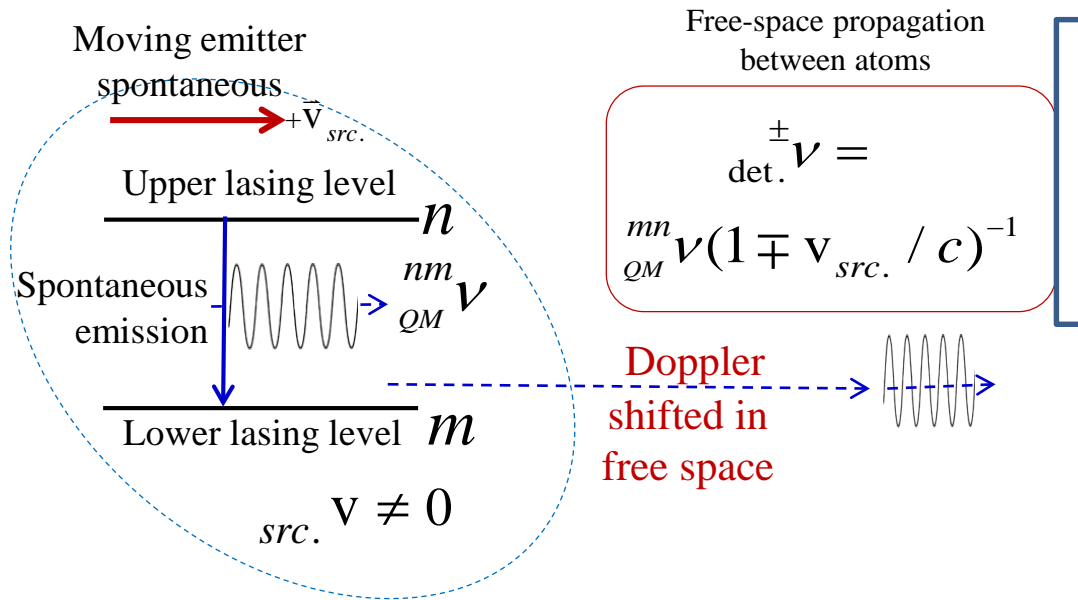

# Spontaneous & stimulated emissions tell source & detector velocities are discernible for actual & apparent Doppler Shifts!

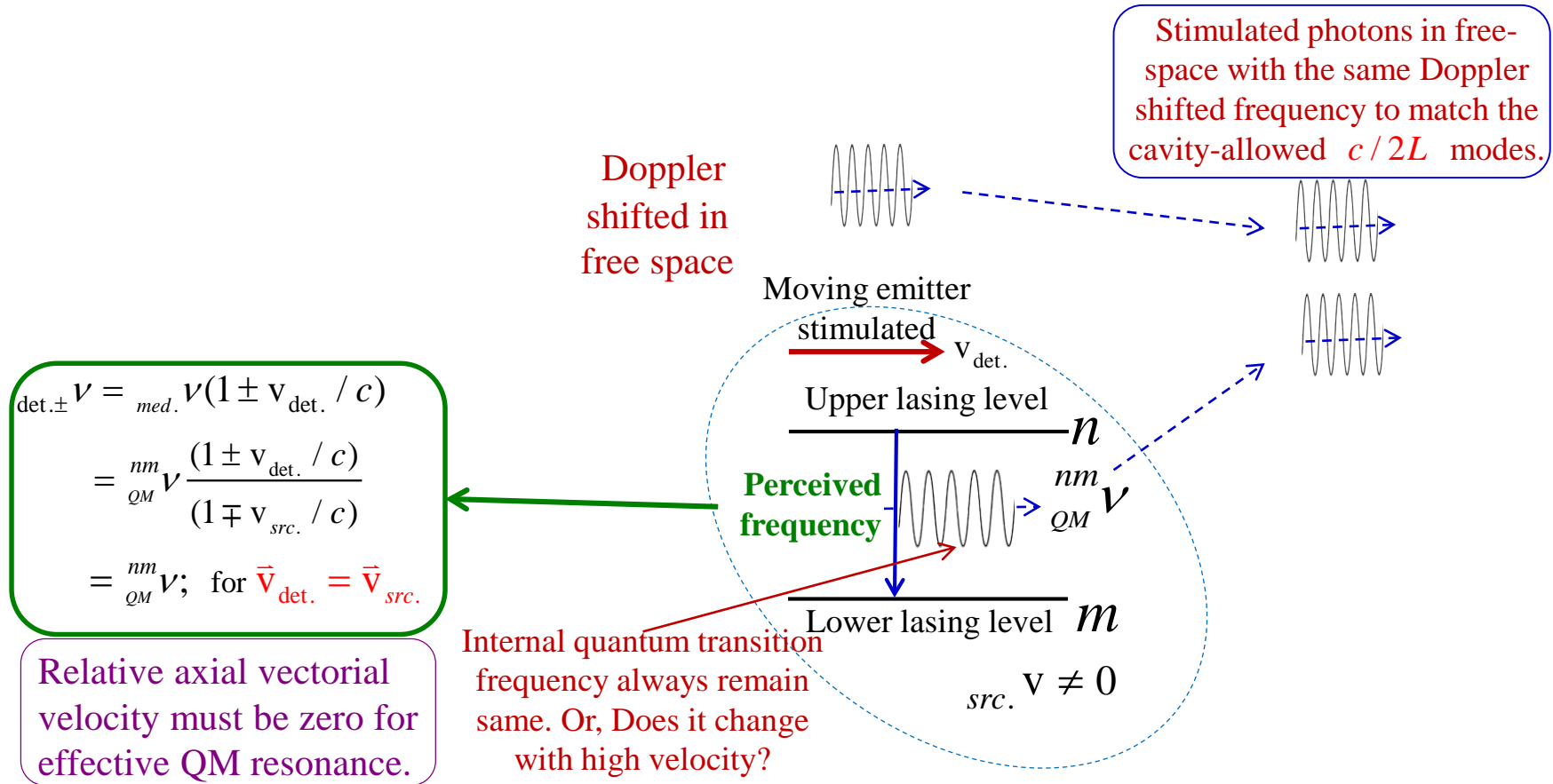

# Spontaneous & stimulated emissions tell source & detector velocities are discernible for actual & apparent Doppler Shifts!

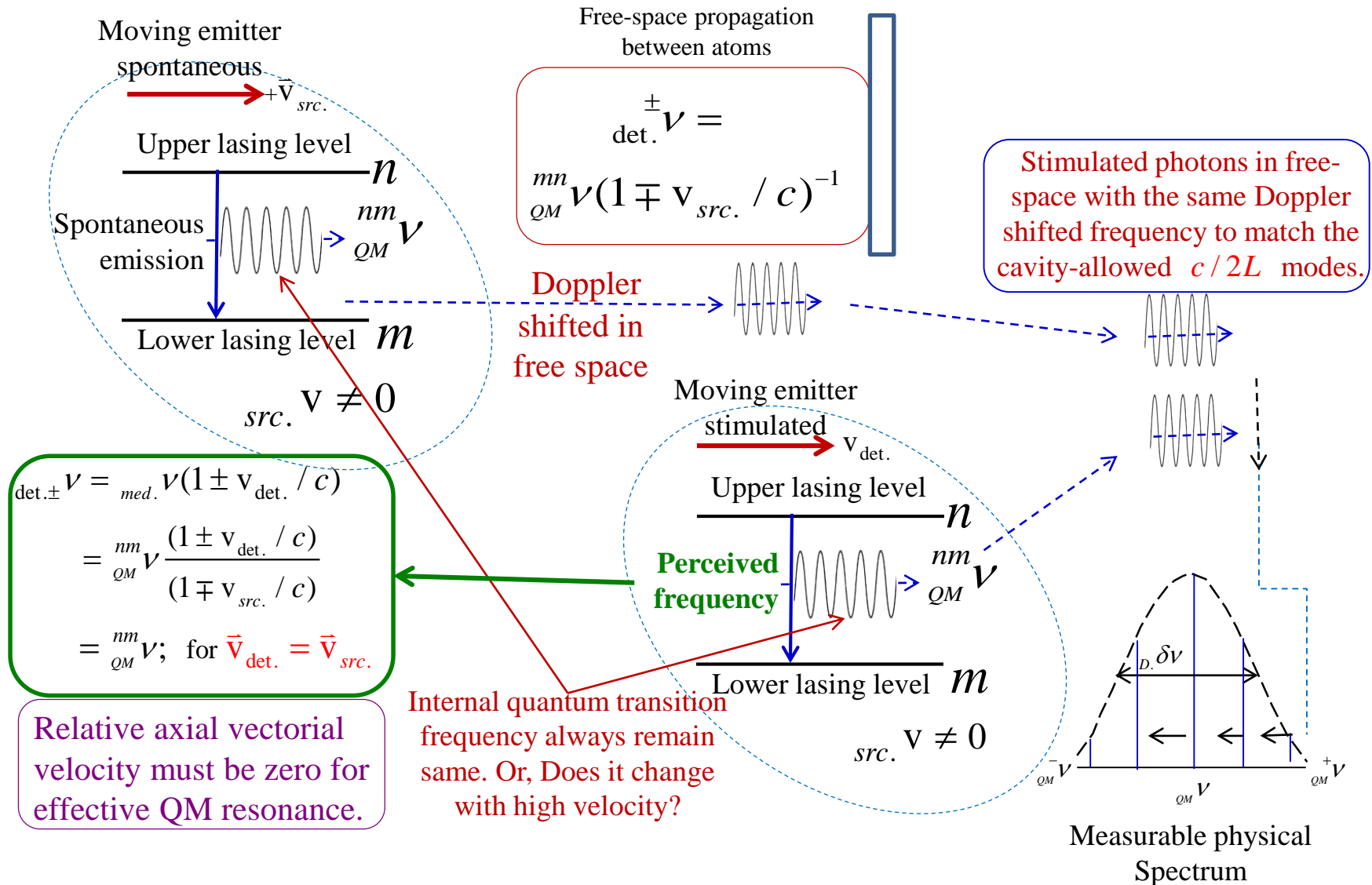

$$\begin{aligned} \nu_{det. \pm} &= \nu_{med.} \nu (1 \pm \nu_{det.} / c) \\ &= nm_{QM} \nu \frac{(1 \pm \nu_{det.} / c)}{(1 \mp \nu_{src.} / c)} \\ &= nm_{QM} \nu; \text{ for } \vec{\nu}_{det.} = \vec{\nu}_{src.} \end{aligned}$$

Relative axial vectorial velocity must be zero for effective QM resonance.

Internal quantum transition frequency always remain same. Or, Does it change with high velocity?





**Understanding the physical process steps  
behind the Doppler shift induced line  
broadening implies Cosmological (Hubble)  
Redshift cannot be due to Doppler Effect.**

# Understanding absorption spectroscopy

## Lab absorption spectrometry

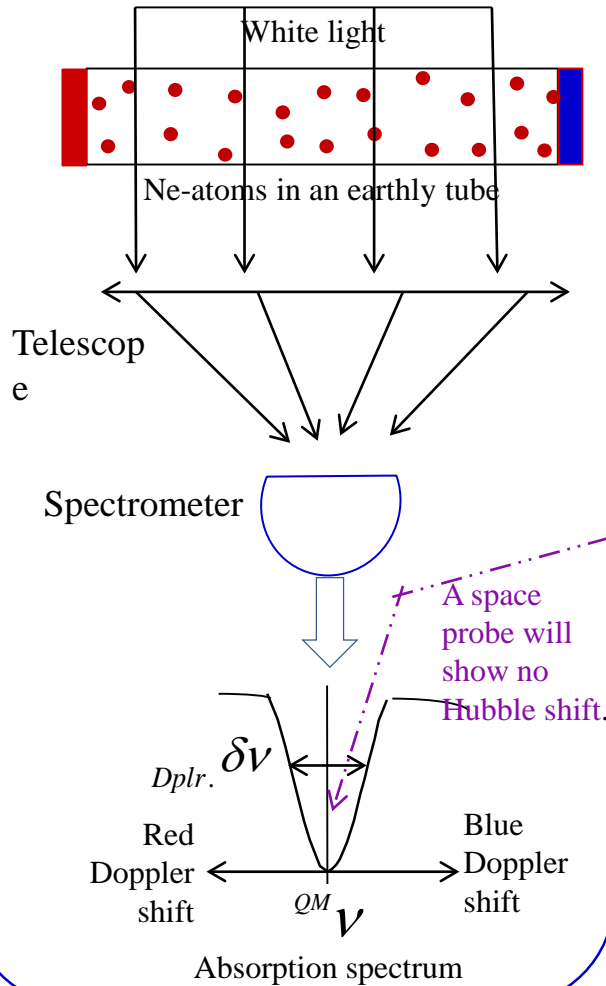

# Do the atoms move with respect to the “star-frame”, or the “earth-frame”, or the “lab-frame” or the “vacuum-frame” (CTF)?

# We posit that it is the “Vacuum-frame” (CTF), which is stationary everywhere!

# Like the stimulated emission frequency, the absorption freq. is determined by the velocity of the “detector” only!

C.R., “Hijacking of the 'holographic principle' by cosmologists”; Proc. SPIE Paper #8833-15

## Stellar absorption spectrometry

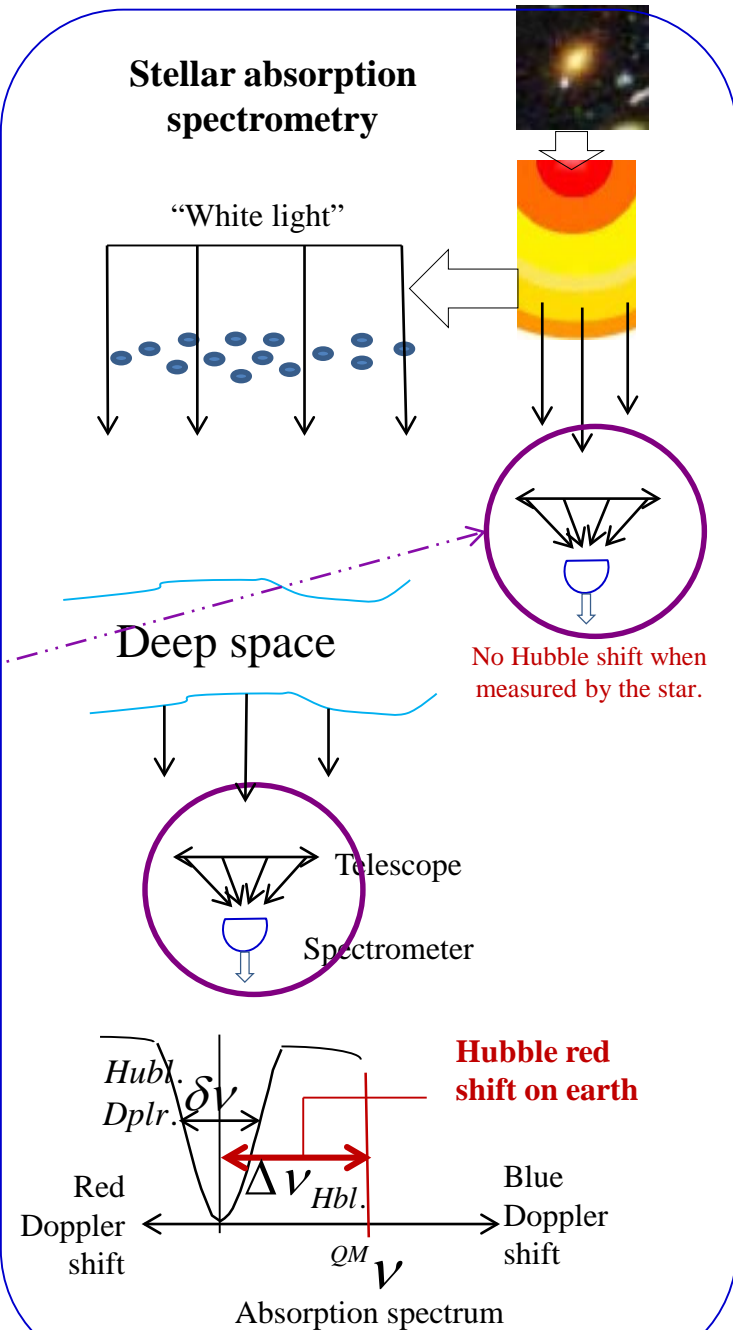

# Absorption lines, a non-signal, cannot undergo physical changes!

## Real physical signal is the white light emitted in the inner corona of stars!

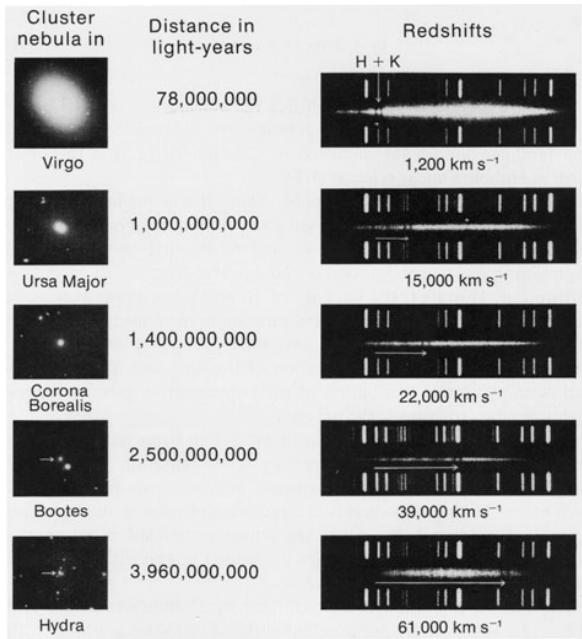

Emission and absorption physical processes are identical in all stars.

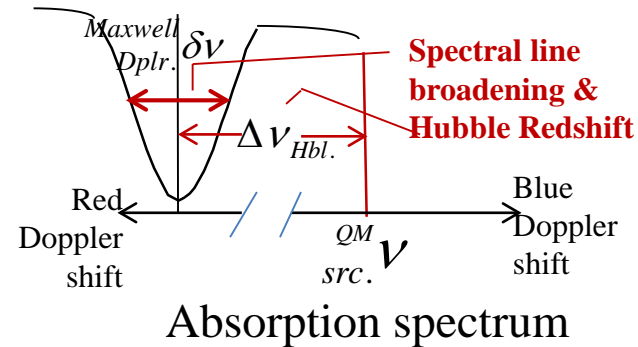

$$\left[ \text{Hubl. Redshift } \Delta v \right] \text{ Due to travel to earth.} \gg \gg \left[ \text{Maxwell Dopler } \delta v \right] \text{ Due to atoms' vel. in star.}$$

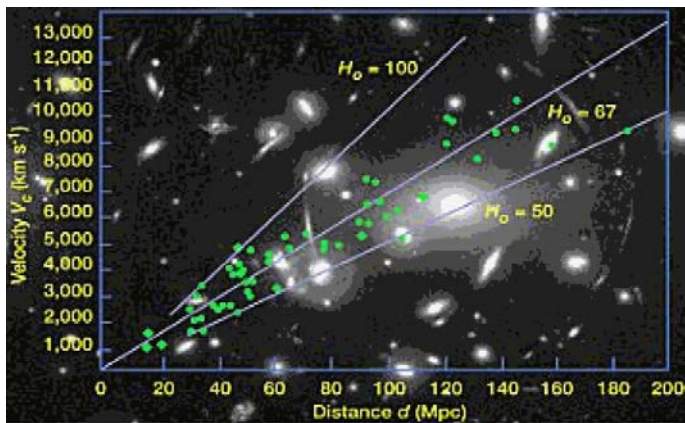

[http://astro.wku.edu/astr106/H\\_K\\_redshift.jpg](http://astro.wku.edu/astr106/H_K_redshift.jpg)

We posit that Cosmological (Hubble) Red Shift during cosmic travel of star light is different from source/emitter velocity dependent Doppler shift.  
**Do we really have an expanding universe?**

C.R., "Hijacking of the 'holographic principle' by cosmologists"; Proc. SPIE Paper #8833-15

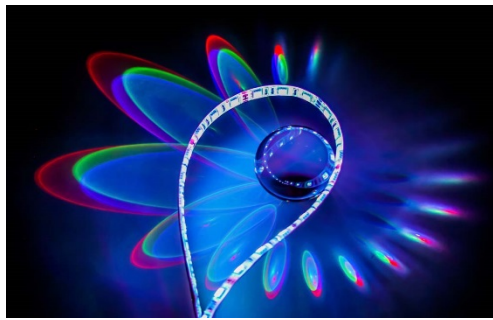

## **What is my model for the Cosmological Redshift?**

**A linear-distance-dependent frequency-drag-down property of CTF.**

## Hypothesis: CTF's imposes mild non-dispersive frequency-drag-down with distance of propagation

$$E(z, t) = a(t) \exp i k [z \pm ct] = a(t) \exp i [2\pi\nu \{ (z/c) \pm t \}]$$

$$E(z, t) = a(t) \exp i [2\pi(\nu_0 - \alpha t) \{ (z/c) \pm t \}]$$

The modified red-shifted frequency of the light arriving on the Earth from a galaxy at a distance  $D$  from the Earth will take a time  $\tau = D/c$  :

$$E_{Galx.-Erth}(z, t, \tau) = a(t) \exp i 2\pi(\nu_0 - \alpha\tau) [(z/c) \pm t]$$

$$\nu = H_0 D \text{ (Hubble's Rule); } \nu = c\delta\nu / \nu_0 \text{ (Doppler's Rule)}$$

$$\nu = H_0 D = c\delta\nu / \nu_0 = c\alpha\tau / \nu_0 = \alpha D / \nu_0$$

$$\text{Or, our } \alpha = H_0 \nu_0 \approx (2.5 \times 10^{-18} \text{ sec}^{-1}) \nu_0$$

This is pure “back-calculation” using MDM-E with a different hypothesis.

Could this hypothesis be verified through some other experiments by tracking the changes necessary to enforce on Maxwell's wave equation?

**More work needs to be done!**



**Use Doppler shift spectrometry to determine  
the absolute vectorial velocity of Steller  
objects with respect to the stationary CTF**

## Use Doppler shift spectrometry to determine the absolute vectorial velocity of the Sun with respect to the stationary CTF

Send a rocket with a spectrometer at an elliptical orbit to the desired star that will have widely varying velocity during its orbiting. Slowly spin the spectrometer and keep recording some strong spectral line whose Doppler-free line center is well-known. When the spectrometer exactly registers this line center, the vectorial velocity of the rocket at that moment is identical to that of the absolute vectorial velocity of the star.

$$\begin{aligned} \vec{v}_{det. \pm} &= \vec{v}_{med.} (1 \pm v_{det.} / c) \\ &= \frac{nm_{QM}}{1 \mp v_{src.} / c} \vec{v} \\ &= nm_{QM} \vec{v}; \text{ for } \vec{v}_{det.} = \vec{v}_{src.} \end{aligned}$$

$\vec{v}_{rocket} = \vec{v}_{Sun}$  when the spectral line center registers  $\frac{nm_{QM}}{1 \mp v_{src.} / c} \vec{v}$ .

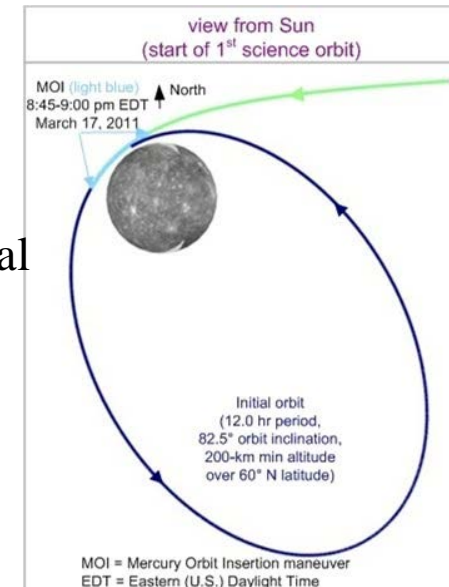

# We already have the necessary precision spectrometric tools. Exoplanet detection by Doppler shift measurement due to relative velocity

The measurement approach relies upon measurement of differential Doppler frequency shift equating with the differential relative velocity

$$\delta\nu = \frac{nm}{QM} \nu (\delta v / c)$$

**Assumption:** Quantum transition frequency is same in all galaxies!

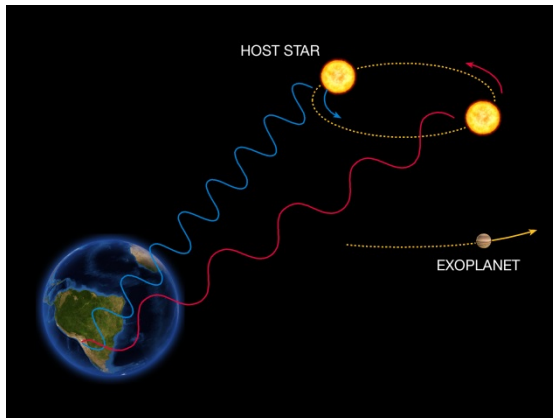

The Radial Velocity Method

ESO Press Photo 22e/07 (25 April 2007)

This image is copyright © ESO. It is released in connection with an ESO press release and may be used by the press on the condition that the source is clearly indicated in the caption.

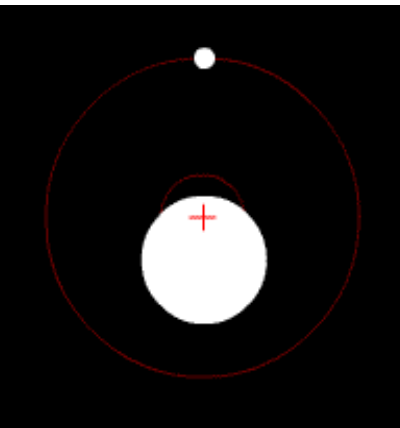

[https://en.wikipedia.org/wiki/Doppler\\_spectroscopy](https://en.wikipedia.org/wiki/Doppler_spectroscopy)

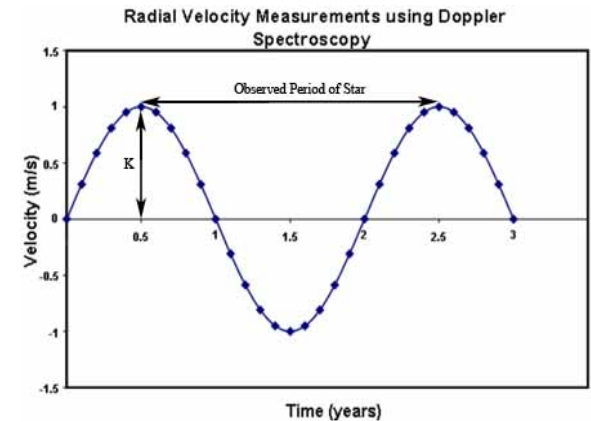

$$\det.\pm \nu = \frac{nm}{QM} \nu \frac{(c \pm v_{\det.})}{(c \mp v_{src.})}$$

$$\det.\pm \nu = \frac{nm}{QM} \nu (1 + \delta v/c); \text{ for } v \ll c. \quad \delta\nu = \frac{nm}{QM} \nu (\delta v / c)$$





**How to measure the cosmic stationarity of CTF?**

# We need to measure the real velocity of light in CTF.

M-M experiment tries to measure relative phase difference!

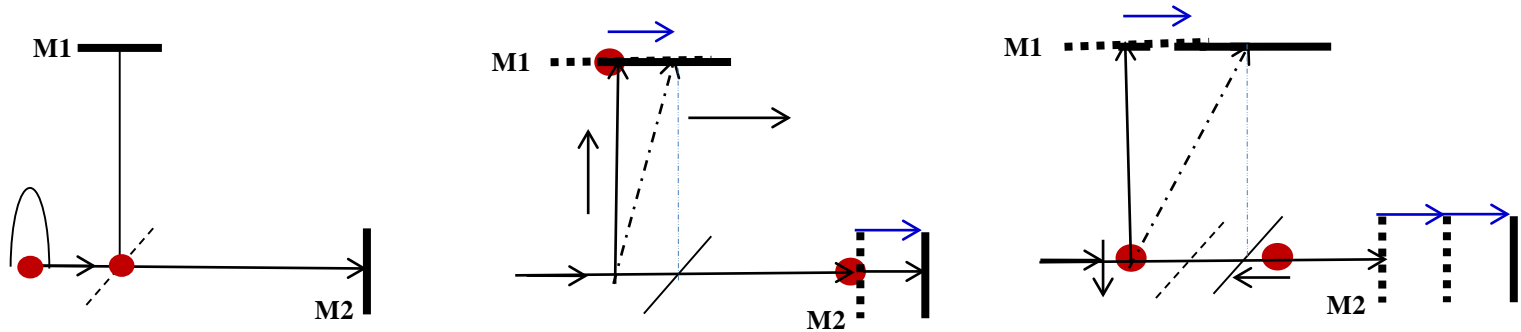

A short pulse of light illustrates the point. The M-M interferometer is immersed in stationary air or stationary CTF (modified ether). Light travel direction is completely controlled by the Poynting vector, not by the direction of the movement of the interferometer. So, the pulse on its vertical journey, on arrival, may just get reflected from the edge of the top mirror. On its return, it may not even encounter the beam splitter, if the interferometer arm-length is made very very long! No interferometry can be done either in air or in vacuum.

# We need to measure the real velocity of light in CTF.

M-M experiment tries to measure relative phase difference!

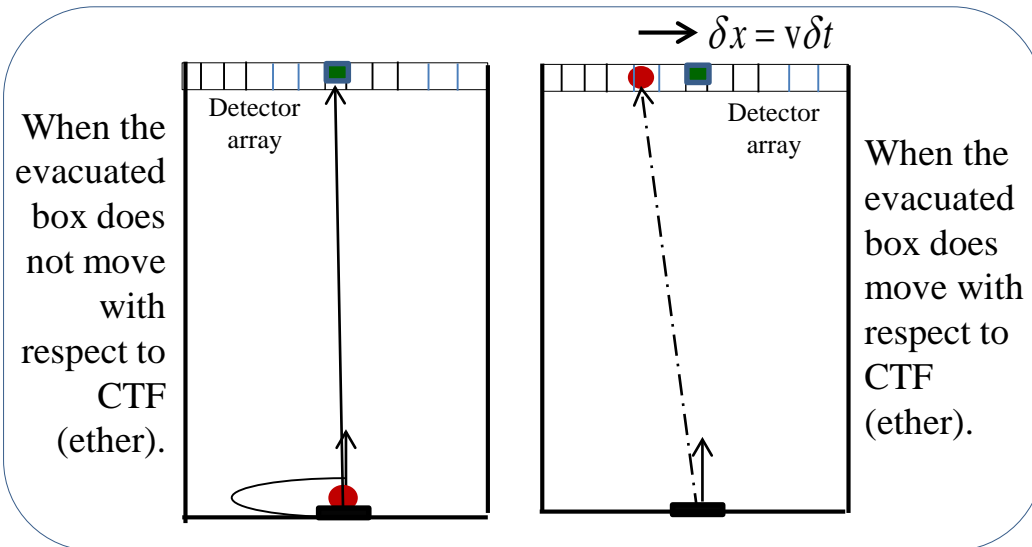

## Measuring non-drift of ether (CTF) in deep space. Or, one-way velocity of light!

- Exploit earth's orbital velocity 30km/s
- Use "centering" detector array of pitch 100 micron.
- The necessary distance between the pico second pulsed diode and the detector array should be a minimum of 1meter. For 1 pixel shift in the arrival of light.

# We need to measure the real velocity of light in CTF.

## M-M experiment tries to measure relative phase difference!

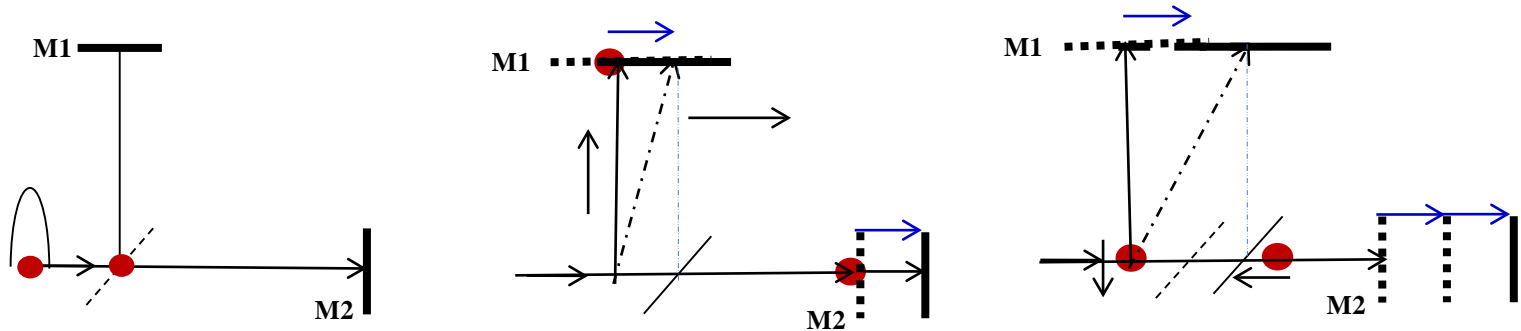

A short pulse of light illustrates the point. The M-M interferometer is immersed in stationary air or stationary CTF (modified ether). Light travel direction is completely controlled by the Poynting vector, not by the direction of the movement of the interferometer. So, the pulse on its vertical journey, on arrival, may just get reflected from the edge of the top mirror. On its return, it may not even encounter the beam splitter, if the interferometer arm-length is made very very long! No interferometry can be done either in air or in vacuum.

When the evacuated box does not move with respect to CTF (ether).

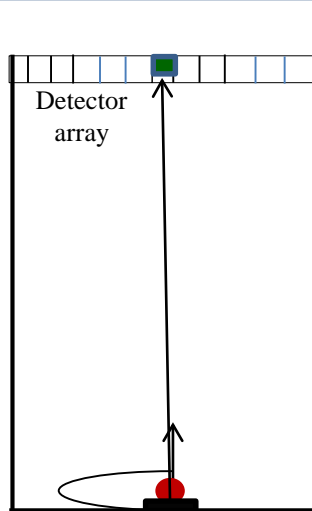

When the evacuated box does move with respect to CTF (ether).

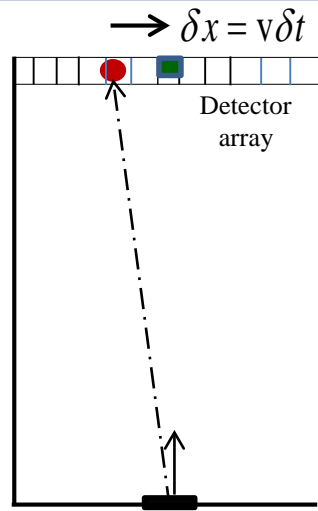

### Measuring non-drift of ether (CTF) in deep space. Or, one-way velocity of light!

- Exploit earth's orbital velocity 30km/s
- Use "centering" detector array of pitch 100 micron.
- The necessary distance between the pico second pulsed diode and the detector array should be a minimum of 1meter. For 1 pixel shift in the arrival of light.

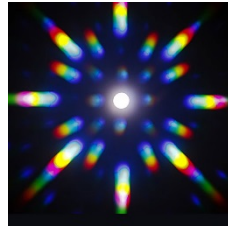

# Summary

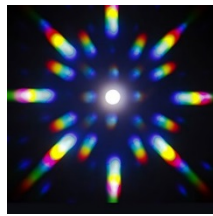

# Summary

**To accommodate NIW, the space needs to be a stationary Complex Tension Field (CTF):**

- (i) EM waves and particles are simply different kinds of excited states of the same stationary CTF and hence the absence of MMX- ether drag.
- (ii) Atoms experience the same stationary CTF everywhere in the universe. And, hence the same laws of physics are obeyed everywhere.
- (iii) Doppler effects due to source velocity and detector velocities are discernible for both the terrestrial and Stellar sources.
- (iv) Cosmological Redshift cannot be due to Doppler Effect. Alternate explanation is suggested.
- (v) Space experiments have been proposed to determine the stationarity of CTF (one-way light velocity).
- (vi) Space experiments have been proposed to determine the absolute velocities of Stellar objects (spectrometer receiver on rocket to recover quantum transition frequency of specific lines).

***To be successful space travelers:***

**We must learn to utilize the various embedded tension energies anywhere in space.  
CTF holds 100% of the cosmic energy.**



## Are there any questions?

- ❖ We never know **what is absolutely true!**
- ❖ Physics must try to map the **interaction processes.**
- ❖ Technology innovation is simply emulation of **interaction processes** allowed in nature
- ❖ Demand on process visualization will automatically force us to **keep on iterating our theories for continuous evolution.**
- ❖ Working theories should be used to explore our **further ignorance** about nature.

My paper download site through UConn Physics: <http://www.natureoflight.org/CP/>